

## Digital Pressure Transducer

# CPT6010

mentor

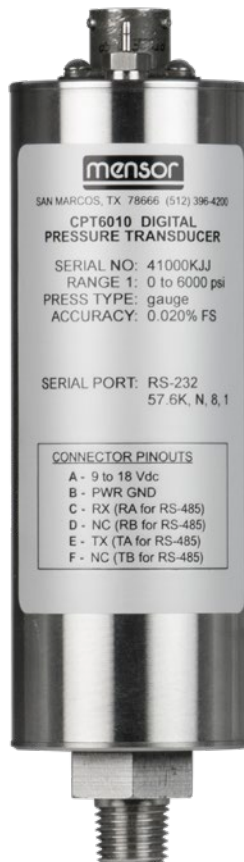



**Warning**

**This Warning symbol indicates that danger of injury for persons and the environment and/or considerable damage (mortal danger, danger of injury) will occur if the respective safety precautions are not taken.**



**Caution**

**This Caution symbol indicates danger for the system and material if the respective safety precautions are not taken.**



**Notice**

**This Notice symbol does not indicate safety notices but information for a better understanding of the facts.**

# Contents

<b>1. General Information</b>	<b>5</b>
1.1 Warranty	5
1.2 Important Notice	5
1.3 Software License Agreement	6
1.4 Mensor Service Plus	6
1.4.1 After the Warranty	6
1.4.2 Calibration Services	6
1.4.3 Accreditations	6
<b>2. Safety Notices</b>	<b>7</b>
2.1 Warnings and Caution Notices	7
<b>3. Product Description</b>	<b>9</b>
3.1 General Description	9
3.2 Turndowns	9
3.3 Power Supply	9
3.4 Sensor	9
3.5 Circuitry	9
3.6 Serial In/Out Communications	9
<b>4. Specifications</b>	<b>11</b>
<b>5. Installation</b>	<b>13</b>
5.1 Unpacking the instrument	13
5.2 Dimensions	13
5.3 Configuration	13
5.4 Mounting	13
5.5 Pressure Connections	14
5.6 Electrical Connections	14
5.6.1 Connector J1 Wiring	14
5.6.2 RS-232 Operation	14
5.6.3 RS-485 Operation	15

# Digital Pressure Transducer CPT6010

<b>6. Operation</b>	<b>17</b>
6.1 Multiple Turndown Devices	17
6.1.1 Filter Effects of Multiple Turndowns	17
6.2 Serial Port Configuration	18
6.3 CPT6010 Address	18
6.3.1 Addressing Devices with two Turndowns	18
6.4 Communication Syntax and Command Conventions	19
6.4.1 Wildcard Address Operator (*)	19
6.4.2 Password Protection	19
6.4.3 Response String Format	19
6.4.4 Commands and Queries	20
6.4.5 Pressure Unit Code and Conversion	21
<b>7. Calibration</b>	<b>23</b>
7.1 Environment	23
7.2 Equipment	23
7.3 Pressure Standard	25
7.4 Calibration Medium	25
7.5 Calibration Process	25
7.6 Correction Value Query	25
7.7 Zero Adjustment	26
7.7.1 Gauge/Differential Zero Offset	26
7.7.2 Absolute Zero Offset	27
7.8 Span Adjustment	28

## 1. General Information

### 1.1 Warranty

All products manufactured by Mensor are warranted to be free of defects in workmanship and materials for a period of one year from the date of shipment. No other express warranty is given, and no affirmation of Seller, by words or actions, shall constitute a warranty. SELLER DISCLAIMS ANY IMPLIED WARRANTIES OF MERCHANTABILITY OR FITNESS FOR ANY PARTICULAR PURPOSES WHATSOEVER. If any defect in workmanship or material should develop under conditions of normal use and service within the warranty period, repairs will be made at no charge to the original purchaser, upon delivery of the product(s) to the factory, shipping charges prepaid. If inspection by Mensor or its authorized representative reveals that the product was damaged by accident, alteration, misuse, abuse, faulty installation or other causes beyond the control of Mensor, this warranty does not apply. The judgment of Mensor will be final as to all matters concerning condition of the product, the cause and nature of a defect, and the necessity or manner of repair. Service, repairs or disassembly of the product in any manner, performed without specific factory permission, voids this warranty.

MENSOR MAKES NO WARRANTY OF ANY KIND WITH REGARD TO THIS MANUAL, INCLUDING, BUT NOT LIMITED TO, THE IMPLIED WARRANTIES OF MERCHANTABILITY AND FITNESS FOR A PARTICULAR PURPOSE. Mensor shall not be liable for errors contained herein or for incidental or consequential damages in connection with the furnishing, performance, or use of this material.

### 1.2 Important Notice

The product specifications and other information contained in this manual are subject to change without notice.

Mensor has made a concerted effort to provide complete and current information for the proper use of the equipment. If there are questions regarding this manual or the proper use of the equipment, contact either Mensor or WIKA:

Mensor  
201 Barnes Drive  
San Marcos, TX 78666  
tel: 1-512-396-4200  
1-800-984-4200 (USA only)  
website: [www.mensor.com](http://www.mensor.com)  
fax: 1-512-396-1820  
email: [sales@mensor.com](mailto:sales@mensor.com)  
[tech.support@mensor.com](mailto:tech.support@mensor.com)

WIKA Alexander Wiegand SE & Co. KG  
Alexander-Wiegand-Straße 30  
D-63911 Klingenberg / Germany  
tel: (+49) 93 72/132-5015  
website: [www.wika.de](http://www.wika.de)  
fax: (+49) 93 72/132-8767  
email: [CTsales@wika.com](mailto:CTsales@wika.com)

Any reproduction of this manual or parts thereof by any means is prohibited.

# Digital Pressure Transducer CPT6010

## 1.3 Software License Agreement

This product contains intellectual property, i.e., software programs, that are licensed for use by the end user/customer (hereinafter “end user”).

This is not a sale of such intellectual property.

The end user shall not copy, disassemble or reverse compile the software program.

THE SOFTWARE PROGRAMS ARE PROVIDED TO THE END USER “AS IS” WITHOUT WARRANTY OF ANY KIND, EITHER EXPRESS OR IMPLIED, INCLUDING, BUT NOT LIMITED TO, WARRANTIES OF MERCHANTABILITY AND FITNESS FOR A PARTICULAR PURPOSE. THE ENTIRE RISK OF THE QUALITY AND PERFORMANCE OF THE SOFTWARE PROGRAM IS WITH THE END USER.

MENSOR AND ITS SUPPLIERS SHALL NOT BE HELD TO ANY LIABILITY FOR ANY DAMAGES SUFFERED OR INCURRED BY THE END USER (INCLUDING, BUT NOT LIMITED TO, GENERAL, SPECIAL, CONSEQUENTIAL OR INCIDENTAL DAMAGES INCLUDING DAMAGES FOR LOSS OF BUSINESS PROFITS, BUSINESS INTERRUPTION, LOSS OF BUSINESS INFORMATION AND THE LIKE), ARISING FROM OR IN CONNECTION WITH THE DELIVERY, USE OR PERFORMANCE OF THE SOFTWARE PROGRAM.

## 1.4 Mensor Service Plus

If you have problems and you don't find the answer in this manual, contact Mensor at 1.800.984.4200 (USA only) or 1.512.396.4200 for personal assistance, or at any of the contact addresses listed on the rear cover of this manual. We are ready to help.

### 1.4.1 After the Warranty

Mensor's concern with the performance of this instrument is not limited to the warranty period. We provide complete repair, calibration and certification services after the warranty for a nominal fee.

### 1.4.2 Calibration Services

In addition to servicing our own products Mensor can perform a complete pressure calibration service, up to 20,000 psi, for all of your pressure instruments. This service includes an accredited calibration.

### 1.4.3 Accreditations

Mensor is registered to ISO 9001:2008. The calibration program at Mensor is accredited by A2LA, as complying with both the ISO/IEC 17025:2005 and the ANSI/NCSL Z540-1-1994 standards.

## 2. Safety Notices

## 2.1 Warnings and Caution Notices



### Warning

**Not explosion proof. Installation of this instrument in an area requiring devices rated as intrinsically safe is not recommended.**



### Caution

**Use pressure media compatible with 316 SS. This instrument is not designed for oxygen use.**



**Caution: ESD PROTECTION REQUIRED.** The proper use of grounded work surfaces and personal wrist straps are required when coming into contact with exposed circuits (printed circuit boards) to prevent static discharge to sensitive electronic components.



### Caution

**Avoid excessive overpressure to the sensor! Externally mounted relief valves to provide overpressure protection are available from Mensor as optional devices and are highly recommended for very low pressure transducers.**

**Digital Pressure Transducer  
CPT6010**

**NOTES**



### 3. Product Description

#### 3.1 General Description

The CPT6010 Digital Pressure Transducer (CPT6010) is a self-contained pressure sensing device that provides high accuracy pressure measurements. This transducer incorporates a low hysteresis silicon sensor with electronically compensated pressure linearity over the specified temperature range. Communication with the CPT6010 is over a serial bus, either RS-232 or RS-485.

One end of the CPT6010 has a 1/4" NPT male fitting pressure port, and the opposite end has a six pin power/signal connector (J1) and a #10-32 reference pressure port (for gauge pressure only). (See Figure 5.2 - Outline drawing)

#### 3.2 Turndowns

The transducer has the capability to include two distinct ranges (turndowns) using a single sensor. The primary turndown is always the higher range of the transducer. The second turndown has exactly the same performance specifications, but at some lower full scale range which is not less than half the primary turndown range. At powerup the primary turndown is active by default.

#### 3.3 Power Supply

The required 9-18 VDC power enters the CPT6010 via J1. All of the transducer electronics and communications share a common ground.

#### 3.4 Sensor

The pressure sensor is secured to the transducer case and the 1/4 NPT fitting. The case includes a #10-32 threaded opening which is the reference pressure port for gauge, vacuum or bi-directional type sensors.

#### 3.5 Circuitry

All of the circuitry for the CPT6010 is included on a single PC board. The combined pressure and temperature sensor signals are routed to the signal conditioning electronics.

#### 3.6 Serial In/Out Communications

The serial bus is set to either RS-232 or RS-485 at the factory. The bus is a two-way communication path used to receive commands and return measured pressure values and other transducer information to the user. This port is also used to transmit calibration adjustments and other user functions to the CPT6010. Pressure units for each transducer are specified by the customer. Wiring requirements for the serial port are provided in section 5, Installation, and a list of valid commands and responses (see Table 6.4.4 - Commands and Queries) is provided in section 6, Operation.

# Digital Pressure Transducer CPT6010

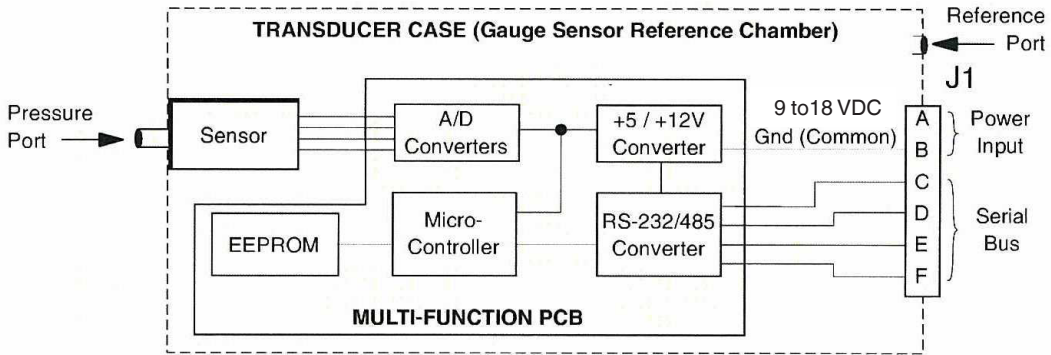

Figure 3.6 - CPT6010 Block Diagram

## 4. Specifications

Accuracy specifications presented herein are obtained by comparison with primary standards traceable to the National Institute of Standards and Technology (NIST). These specifications are obtained in accordance with the ISO Guide to the Expression of Uncertainty in Measurement (GUM). The calibration program at Mensor is accredited by the American Association of Laboratory Accreditation (A2LA) as complying with both the ISO/IEC 17025:2005 and the ANSI/NCSL Z540-1-1994 standards.

Mensor reserves the right to change specifications without notice.

Total Uncertainty	0.020% FS. Total Uncertainty (k=2) includes hysteresis, linearity, repeatability, reference standard, drift and temperature effects over the calibrated range for the calibration interval specified, with periodic re-zeroing.
Calibration Stability (after warm-up)	Less than 0.02% FS for 180 days with periodic rezeroing. Zero and Span may be reset via the serial interface without affecting linearity.
Calibration Interval	180 days
Calibration Adjustments	Zero and Span via the serial interface
Pressure Ranges	Absolute: 0 ... 7.5 psia up to 0 ... 6015 psia Gauge: 0 ... 5 psig up to 0 ... 6000 psig Bidirectional: -2.5 ... 2.5 psig up to -15 ... 6000 psig
Special Pressure Ranges	Vacuum or bi-directional ranges. Metric pressure units also available.
Pressure Units	Selected from a list of 35: psi, inHg @ 0°C and 60°F, inH2O @ 4°C, 20°C and 60°F, ftH2O @ 4°C, 20°C and 60°F, mTorr, inSW @ 0°C, ftSW @ 0°C, ATM, bars, mbars, mmH2O @ 4°C, cmH2O @ 4°C, MH2O @ 4°C, mmHg @ 0°C, cmHg @ 0°C, Torr, hPa, mPa, kPa, Pa, D/cmsq, G/cmsq, Kg/cmsq, MSW, OSI, PSF, TSF, TSI, μHg @ 0°C, %fs. All seawater units are 3.5% salinity.
Resolution	From 1 to 10 ppm, depending on measurement units and range
Overpressure Ratings	150% FS or greater, depending on range
Compensated Temperature Range	15°C to 45°C
Warm-up	10 minutes to rated accuracy

## Digital Pressure Transducer CPT6010

Reading Rate	50 per second
Communications	RS-232 or RS-485. LabVIEW® drivers are available. (LabVIEW® is a trademark of National Instruments Corporation.)
Max Transmission	4000 feet (RS-485)
Multi-drop Capacity	The maximum number of RS-485 CPT6010 transducers which can be connected to a single host computer is 31.
Mechanical Shock	5g max
Case Size	1.74" wide x 6.3" long (4.42 x 16 cm), not including pneumatic and electrical connectors.
Weight	Approximately 12 ounces (28.3 grams)
Pressure Media	All media compatible with 316L stainless steel.
Fittings	Pressure Port: 1/4 inch male NPT Reference Port: 1/16 inch barb (gauge instruments only).
Power Required	9-18 VDC, 45mA @ 12 VDC 6 pin Bendix connector #PT02E-10-6P
Options	Relief valves - up to 1000 psig Non-standard ranges

## 5. Installation

### 5.1 Unpacking the instrument

In addition to functional testing, each unit is inspected for appearance prior to leaving the factory. Upon receipt, please examine the transducer for shipping damage. Report any apparent damage to the carrier immediately.

In addition to this manual and password information (files on USB drive), you should have:

- One CPT6010 Digital Pressure Transducer in protective netting;
- One six-pin mating Bendix electrical connector if power/comm cable accessory not ordered;
- Any accessories ordered;
- An envelope containing a Calibration Certificate.

Note: The software utility CD was supplied with this manual prior to 2/2014 but is now downloaded from the Mensor website (see Section 7.2, "Equipment").

### 5.2 Dimensions

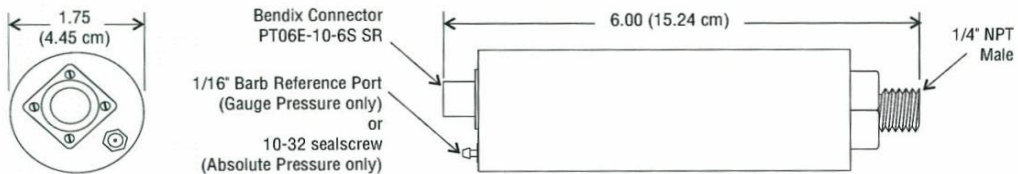

Figure 5.2 - Outline drawing, CPT6010

### 5.3 Configuration

A typical system will consist of an IBM-PC compatible computer with installed driver software, one or more CPT6010's, a DC voltage power supply, and the interconnecting cables. The driver software can be any program configured to operate the appropriate serial interface. Up to 31 CPT6010's can be connected in parallel using RS-485. Refer to Figure 5.6.3 for an illustration of two alternate RS-485 wiring arrangements, including multiple CPT6010 operation.

### 5.4 Mounting

The CPT6010 can be set up in any orientation since the pressure sensor is relatively insensitive to tilt and vibration. However, excessive motor or machinery vibration of the mounting surface should be avoided to further ensure stability and accuracy. For the greatest accuracy on transducers with a full scale range of less than 15 psi, set CPT6010 zero while it is oriented in its operational position.

### 5.5 Pressure Connections

# Digital Pressure Transducer CPT6010

The pressure to be measured is applied to the 1/4 inch NPT fitting. A 10-32 tapped opening on the opposite end is used as the reference port for gauge pressure. This port is normally left open to atmosphere, but it can be connected to another source for a reference pressure.

Use either Loctite® Hydraulic Sealant or fresh teflon tape on the threads of the male pipe fittings when making up pressure connections. The integrity of the seal to the pressure port is important since even microscopic leaks can cause errors in pressure measurements.



**Caution**

**Do not install by grabbing the case and turning it with a wrench or pliers. Use the wrench flats near the pipe threads. Wrench size is 7/8 inch.**

## 5.6 Electrical Connections

### 5.6.1 Connector J1 Wiring

Power and signals are applied to J1, a circular 6 pin male connector. A positive power supply voltage is supplied to pin A, and ground (power and signal common) is connected to pin B. The CPT6010 is protected against power input reversal. A mating connector (Bendix #PT06E-10-6S SR) is shipped with the transducer. Wiring between the host and J1 is described by Figures 5.6.2 and 5.6.3.

### 5.6.2 RS-232 Operation

For RS-232 serial port operation, connect the CPT6010 to the host computer per Figure 5.6.2 Notice that the host TRANSMIT line is connected to the CPT6010 RECEIVE line (TX to RX), and vice versa. One limitation of the RS-232 bus is that a host can support only one instrument. See section 5.6.3, RS-485 Operation, for multiple CPT6010 operation.

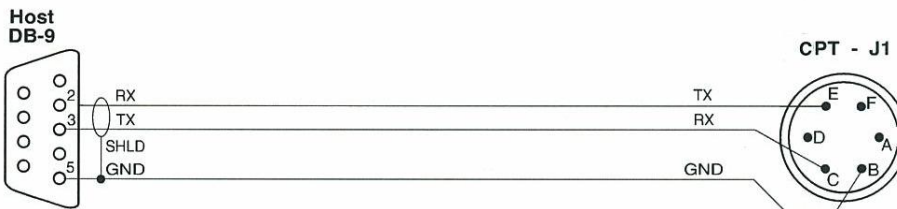

Note: Connectors are female, shown from the wired end.

Figure 5.6.2 - RS-232 Hookup

### 5.6.3 RS-485 Operation

For RS-485 serial operation, connect the host computer to the CPT6010 the diagram shown in Figure 5.6.3. Notice that the host TRANSMIT lines are connected to the CPT6010 RECEIVE lines, TA to RA, TB to RB, and so on.

If only one RS-485 CPT6010 will be connected to the system, disregard the wiring to “CPT #1” and “CPT #2” in the illustrations. Instead, wire the computer directly to the “CPT #31” by the four-wire method.

To connect multiple RS-485 CPT6010's to a single host, use the full multi-drop wiring shown in Figure 5.6.3. Only full duplex (4-wire) connection is recommended. In the configuration, one computer can communicate with up to 31 CPT6010's without a repeater, but each CPT6010 in the system must have a unique address. The signal is simultaneously distributed to each transducer connected to the parallel path. Each CPT6010 responds only to commands or queries directed to its own address. Removal of one or more CPT6010's from the line has no effect on the remaining devices.

Terminating resistor examples are shown and should be determined by the end user when cabling extremes are required. Resistor values are selected to match the characteristic impedance of the transmission line, typically 100 to 120 ohms.



### Notice

**Due to the nature of the various RS-485 converters available there may be communication issues. We have determined that our devices work with the ACCES I/O PRODUCTS devices. At this time we are not in a position to comment on any other make of RS-485 converters and their suitability for use with our products.**

# Digital Pressure Transducer CPT6010

NOTES: 1. All resistors are 1/2 watt, approximately 100 ohm.  
2. Rt = Terminating resistors; two farthest ends only.

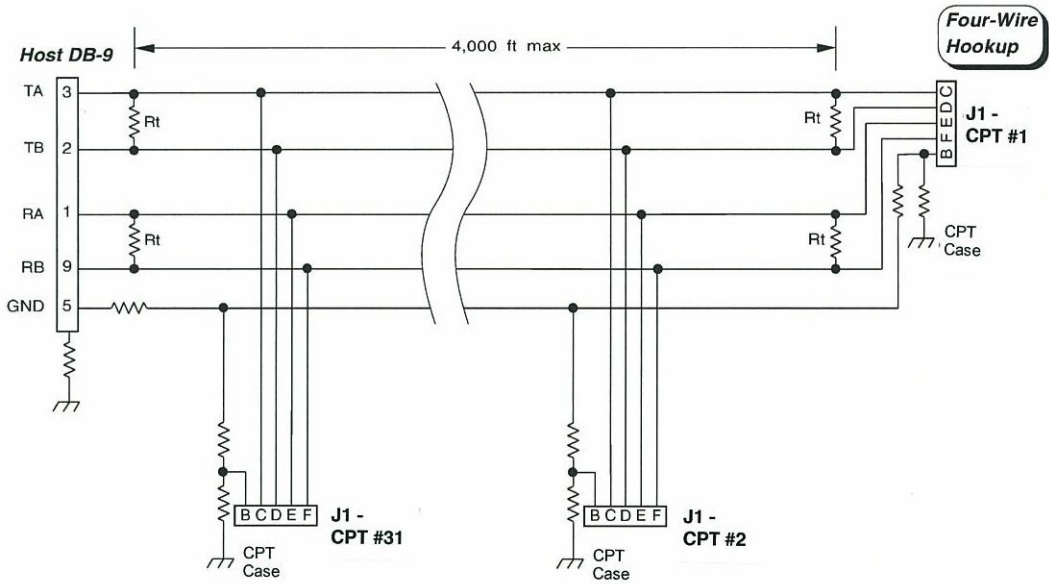

Figure 5.6.3 - RS-485 Cabling



## 6. Operation

The pressure to be measured is applied to the 1/4 NPT fitting on the CPT6010.



### Caution

**Avoid excessive overpressure to the sensor! Externally mounted relief valves to provide overpressure protection are available from Mensor as optional devices, and are highly recommended for very low pressure transducers.**

A CPT6010 samples the pressure every 20 milliseconds (50 Hz).

User programmable exponential filtering is applied to pressure readings in order to minimize at or near static pressure noise. The filter value can range from 0 (filter OFF) to 99 (maximum filtering). For any positive filter value, the filter is disabled when the pressure change between consecutive readings is greater than 0.02% full scale. However, each pressure change of 0.02% FS, or less, between consecutive readings will apply the exponential filter to the output pressure value to smooth out the readings.

The user can reset the zero and span values via the serial port in order to calibrate the instrument, or the user can change any of several other operating values. The user can also query the device for its current pressure reading, or to find the current settings for other parameters.

The serial port is set at the factory for either RS-232 or for RS-485 serial operation according to the customer's instructions. This section of the manual provides information on the serial port configuration, explains the command conventions used in this manual, and lists the common commands and queries which are recognized by the CPT6010.

### 6.1 Multiple Turndown Devices

The availability of two different turndown ranges in one device has many obvious benefits, but certain issues should be noted for application of devices with multiple ranges. An important factor to remember is that the two ranges are completely discrete. Consequently, any and all parameters can be set to different values between the two turndown ranges. The independence of the two ranges has a specific impact on application of the transducer that is detailed below and in section 6.3, CPT6010 Address.

#### 6.1.1 Filter Effects of Multiple Turndowns

An area of concern when using devices with multiple turndowns is the effect of the exponential filter on the reading output. In the case that a user is emulating an auto-ranging scheme by quickly switching between turndown ranges of one device, the exponential filter can skew the reading output of the device immediately after a switch is made. The reason for this skewing is the persistence of previous pressure samples in the reading buffer and their use in the filtering scheme.

## Digital Pressure Transducer CPT6010

The filter equation for the transducer is as follows where FL is set to 90: If the change in pressure reading is less than 0.02% of the last pressure reading sampled at a 20 mS rate, then the pressure reading = (last filtered pressure \* 90%) + (current sampled pressure \* 10%). Otherwise the pressure reading is equal to the current sampled pressure. Default setting is 90% filtering.

Consequently, the readings from the previous active turndown in the reading buffer of the device affect the current reading. The amount the new reading is affected is a function of the size of the filter percentage setting of the active turndown. The largest offset that will be reported by the newly active turndown is 0.02% FS of the current range. In applications where readings must not slew in immediately after a turndown switch is made, it is advisable to set the filter to zero or to program a delay before the new turndown is read.

### 6.2 Serial Port Configuration

Unless otherwise requested by the customer, the CPT6010 serial ports are set at the factory to the default values listed in the following table.

Table 6.2 - Serial Port Settings

Item	Value
Type	RS-232
Address	1
Baud	9600
Data Bits	8
Parity	None
Stop Bits	1

### 6.3 CPT6010 Address

Each CPT6010 is assigned address “1” at the factory. In a multiple CPT6010 system each transducer must have a unique address. Valid addresses are 0 through 9 and A through Z (upper and lower case are interpreted the same).

#### 6.3.1 Addressing Devices with two Turndowns

A circumstance that must be taken into consideration by users of CPT6010's with two turndowns is the possible use of different addresses on separate turndowns of a single transducer. For example, if the primary turndown is set to address X and the second turndown is set to address Y, if a user switches from turndown one, and attempts to address the secondary turndown with address X, the secondary range of the device will not respond. The simplest solution to this problem is to set both turndown addresses to the same value. Alternately, if the device is not being used in a multi-drop application, the user can simply address both ranges with the wildcard address character (see

6.4.1, Wildcard Address Operator) in the event that the application requires different addresses for the respective turndowns. One example of an application of this sort is if a user requires differentiation of the reading output. Because the response string of the transducer when queried for a pressure reading is always started with the address of the active turndown range, a user can switch between turndowns using the wildcard address string and still have indication of which turndown is reporting the data.

## 6.4 Communication Syntax and Command Conventions

All commands and responses are in ASCII characters; lower and upper case are interpreted the same. Every command or query begins with the pound symbol (#). The question mark (?) and decimal point (.) characters are significant to the CPT6010. All other punctuation characters are ignored. Some commands require a password string. A carriage return (<cr>) or linefeed (<lf>) should terminate each command or query.

### 6.4.1 Wildcard Address Operator (\*)

In addition to the 36 unique addresses available, an asterisk (\*) functions as a wildcard address operator. However, this wildcard must not be used in queries if more than one transducer is connected to a host.

One use for the wildcard address could be when a CPT6010 is pulled out of a multi-drop setup and sent to a calibration facility for recertification. The calibration technician can communicate with the device using the wildcard address without learning or changing its assigned address.

### 6.4.2 Password Protection

Certain commands require a password to be sent before a setting is changed. The password is only good for one command, so the password string must be sent immediately before any password protected command string. The form of the password string is described in Table 6.4.4. However, for calibration protection, the actual password has been replaced with PW in the command string example. See the Password card file for the actual password string to be used in place of PW.

### 6.4.3 Response String Format

The CPT6010 will return an R to indicate that it has received a command or password rather than a query. When programming communication with the CPT6010, it is advisable to look for the R response before sending additional commands or queries.

The full command word is shown in Table 6.4.4 in all capital letters. Other conventions used to describe commands are shown in Table 6.4.3.

Table 6.4.3 - Command Conventions

# Digital Pressure Transducer CPT6010

Convention	Description
X	Address (single character 0 through 9 or A through Z; case insensitive)
*	Wildcard address operator
?	Query operator
<sp>	Space ( )
PW	Password; insert password in place of PW (See password card on USB drive; case insensitive)
n	One character placeholder for digit or decimal point
n...n	Variable length field
R	Ready response
<cr>	Carriage return
<lf>	Linefeed

## 6.4.4 Commands and Queries



Each command that changes a parameter is volatile until the **SAVE** command is issued.

### Notice

Table 6.4.4 - Command Set

Pass- word Protect	Command or Query	Command String	Return String	Description
No	?	#X?<cr>	X<sp>nnnnnnnnn<cr> <lf>	Basic query to return pressure readings.
No	A	#XA<sp>n<cr>	R	Sets address of sensor to 0-9 or A-Z.
No	B?	#XB?<cr>	X<sp>B<sp>n<cr><lf>	Returns the turndown, cal flag
No	DC?	#XDC?<cr>	X<sp>DC<sp>nnnnn <cr><lf>	Returns the date of calibration where nnnnn is mmddy.
Yes	DC	#XDC<sp>nnnn n<cr>	R	Loads the date of calibration where nnnnn is mmddy.
No	FL?	#XFL?<cr>	X<sp>FL<sp>nn<cr> <lf>	Returns the filter – it is the percentage of old reading added to new reading: 0-99.
Yes	FL	#XFL<sp>nn<cr>	R	Sets the filter percentage.
No	FS?	#XFS?<cr>	X<sp>FS<sp>nnnn<cr> <lf>	Returns the %FS accuracy.

No	ID?	#XID? <cr>	X<sp>ID<sp>MENSOR <sp>DPT6000,SN<sp>nn nnnn,V<sp>nnnn<cr><lf>	Returns transducer ID.
N/A	PW	#XPW	R	Disables password protec-tion for the following single com-mand.
No	R-?	#XR-? <cr>	X<sp>R-<sp>n...n <cr><lf>	Returns minimum range value.
No	R+?	#XR+? <cr>	X<sp>R+<sp>n...n <cr><lf>	Returns maximum range value.
No	SAVE	#XSAVE<cr>	R	Saves all data to EEPROM for the current turndown.
No	SC?	#XSC? <cr>	X<sp>SC<sp>n...n <cr><lf>	Returns a span correction multiplier.
Yes	SC	#XSC<sp>n... n<cr>	R	Loads a span correction multiplier.
No	SW	#XSW<sp>n<cr>	R	Switches between 'n'=1 for pri-mary cal or 'n'=2 for secondary cal.
No	T?	#XT? <cr>	X<sp>T<sp>C<cr><lf>	Returns cal type.
No	U?	#XU? <cr>	X<sp>U<sp>n<cr><lf>	Returns pressure unit code. See Table 6.4.5.
No	ZC?	#XZC? <cr>	X<sp>ZC<sp>n...n <cr><lf>	Returns zero correction value in current units.
Yes	ZC	#XZC<sp>n... n<cr>	R	Sets zero correction value in current units.

## 6.4.5 Pressure Unit Code and Conversion

Table 6.4.5 - Pressure Unit Code and Conversion

Code	Unit	PSI Conversion Factor
1	psi	1
2	inHg@0°C	2.036020
3	inHg@60°F	2.041772
4	inH2O@4°C	27.68067
5	inH2O@20°C	27.72977
6	inH2O@60°F	27.70759

## Digital Pressure Transducer CPT6010

7	ftH <sub>2</sub> O@4°C	2.306726
8	ftH <sub>2</sub> O@20°C	2.310814
9	ftH <sub>2</sub> O@60°F	2.308966
10	mtorr (@0°C)	51715.08
11	inSW @ 0°C (3.5% salinity)	26.92334
12	ftSW @ 0°C (3.5% salinity)	2.243611
13	atm	0.06804596
14	Bars	0.06894757
15	mBars	68.94757
16	mmH <sub>2</sub> O@4°C	703.0890
17	cmH <sub>2</sub> O@4°C	70.30890
18	mH <sub>2</sub> O@4°C	0.7030890
19	mmHg@0°C	51.71508
20	cmHg@0°C	5.171508
21	Torr	51.71508
22	Kpa	6.894757
23	Pa	6894.757
24	Dynes/cm <sup>2</sup>	68947.57
25	g/cm <sup>2</sup>	70.30697
26	kg/cm <sup>2</sup>	0.07030697
27	mSW @ 0°C (3.5% salinity)	0.6838528
28	oz/in <sup>2</sup>	16
29	psf	144
30	tsf	0.072
31	% Full Scale	
32	microns Hg @ 0°C	51715.08
33	tsi	0.0005
35	HPa	68.94757
36	MPa	0.006894757

## 7. Calibration

The CPT6010 automatically adjusts the pressure readings for the effects of temperature and non-

linearity within the calibrated temperature range of 15-45°C. Thus, a calibrated CPT6010 operated within its temperature band, and with proper zero and span settings, will provide accurate pressure measurements.

The transducer should have the span verified periodically to insure its stability. Initially, the recommended period between calibrations is as specified (180 days). This period may be extended as confidence is gained in the span stability.

## 7.1 Environment

Whenever possible, calibrate the CPT6010 at the same ambient temperature as its normal operating environment. The temperature should be stable, and within the specified calibration range. In addition, for maximum accuracy, see that the CPT6010 is at rest on a stable platform which is free of vibration and shock, and oriented similar to its final installation attitude. At the factory the CPT6010 is calibrated vertically with the pressure port at the bottom.

## 7.2 Equipment

The following equipment is needed to calibrate a gauge transducer (see Figure 7.2):

1. A downloadable calibration utility program. Go to <http://www.mensor.com>, click "Digital Library", click "Software", click "Instrument software", then click on Operating & Calibration software for the CPT6xxx digital pressure transducer series of digital pressure transducers. The calibration utility program is also available on CD by request.
2. A host computer with a serial port to match the CPT6010 (RS-232 or RS-485), software to run the CPT6010 transducer, and an appropriate cable.
3. Appropriate pressure and vacuum sources and calibration reference standards for the CPT6010's pressure range.
4. Tubing and valves adequate for the pressure range.

Additional equipment required to calibrate sub-atmospheric transducers (absolute, vacuum or bi-directional pressure types) is illustrated in Figure 7.2. These items are:

8. A vacuum pump capable of pumping down to 300 millitorr.
9. A vacuum standard to measure pressures down to 300 millitorr.
10. One additional valve to isolate the vacuum line.

# Digital Pressure Transducer CPT6010

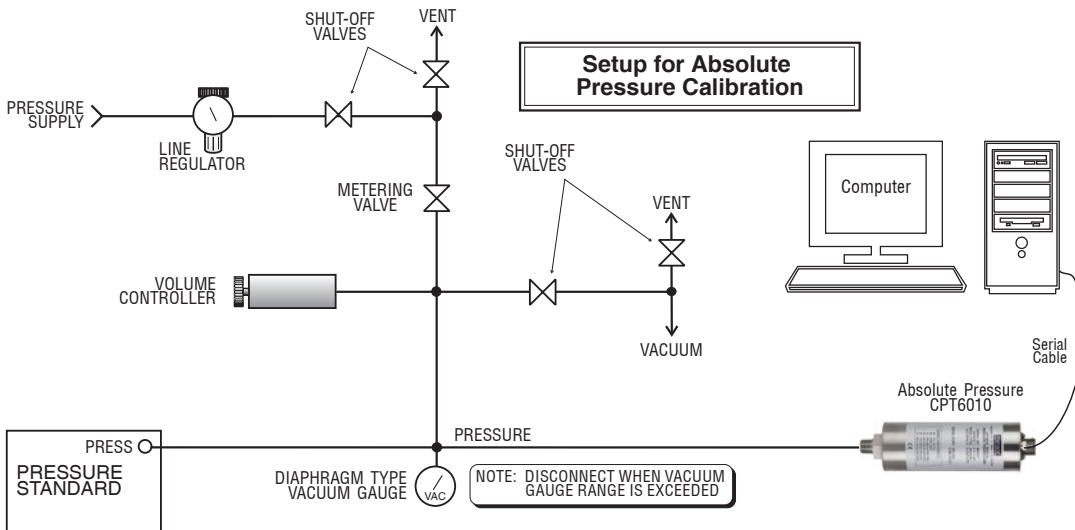
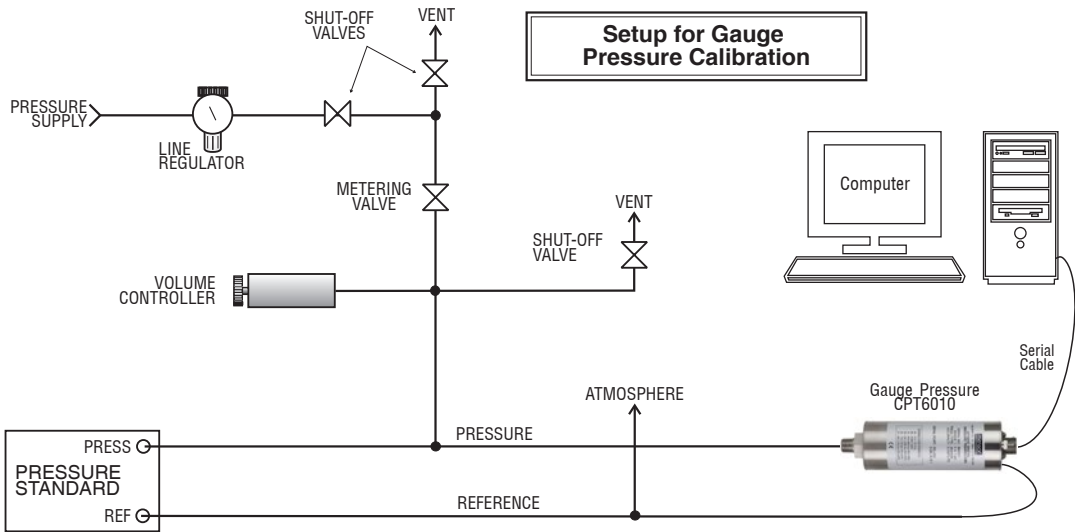

Figure 7.2 - Calibration Setup



### 7.3 Pressure Standard

Mensor recommends the use of appropriately accurate primary pressure standards when calibrating this instrument. Such standards should be sufficient so that when the techniques of the ISO Guide to the Expression of Uncertainty in Measurement (GUM) are applied, the instrument meets its accuracy statements as required by ANSI/NCSL Z540, or other applicable standards. The same requirement applies to the vacuum gauge used to set the zero offset on absolute calibrations. The recommended absolute pressure level for setting the zero offset on an absolute transducer is between 600mTorr absolute and 20% of the active transducer's span.

### 7.4 Calibration Medium

The recommended calibration medium for sensors up to 6000 psi is dry nitrogen or clean, dry instrument air. Hydraulic media (water or oil for example) are recommended for ranges above 6000 psi. Hydraulic media can be used with lower ranges, however, special techniques must be used in filling the connection lines and transducer.

### 7.5 Calibration Process

Please notice that the commands listed in this section are shown in the same style as those in the Operation section. These are the bare commands seen by the CPT6010, stripped of all programming idioms. Depending on the specific language used to generate them, these commands may have to be preceded by or enclosed in various symbols for transmission. For this procedure it is assumed that a single CPT6010 is connected to the host computer, and that its assigned address is unknown.

The model, serial number, and software version number of the CPT6010 being calibrated can be obtained by sending: `#*ID?<cr><lf>`.

### 7.6 Correction Value Query

The stored correction for zero offset or the span correction factor can be retrieved over the bus. The returned values have six significant digits plus a decimal point and a sign. To see the stored values send either:

`#*ZC?<cr><lf>` or `#*SC?<cr><lf>`

These commands may be useful in determining the actual changes in zero and span over time. Unauthorized alterations of the values can be detected by comparison with previously recorded correction values.



#### Notice

**Each command issued to either calibration parameter must be followed by the SAVE command to make it permanent. Otherwise, the changes will be lost the next time the CPT6010 loses power.**

## 7.7 Zero Adjustment

To adjust zero, first determine the correct zero offset, then send the password, and then send the new zero value. Applying the correct zero pressure and finding the resulting zero offset is different for an absolute transducer than it is for a gauge type unit. Once the zero offset is known, the procedure for sending the zero correction value (which sets the output to zero) is the same for either type of transducer. When the zero offset is correct, issue a SAVE command to preserve it in non-volatile memory.

### 7.7.1 Gauge/Differential Zero Offset

Substitute the required password in place of “PW” in the following examples:

1. Determine the current zero offset and make a note of the returned reading.  
Next send: `#*ZC?  
<cr><lf>`  
Record the date and this reading to track zero changes between calibrations.
2. Vent the PRESSURE and REFERENCE ports to atmosphere. The true pressure is now 0 (zero).  
Send: `#*PW  
<cr><lf>`  
Next send: `#*ZC  
<sp>0  
<cr><lf>`  
This will clear the current zero offset from RAM.
3. While vented, determine the current zero pressure reading of the CPT6010.  
Send: `#*?  
<cr><lf>`  
Make a note of the zero value returned by the CPT6010.
4. Subtract the current zero reading from true zero. The difference is the new zero offset.  
Example: For a 0-30 psi unit with both ports vented:  
True pressure = 0 (vented)  
Current pressure reading (from step 4) = +0.0023 psi  
True pressure – current pressure = new offset  
 $0.0000 (-) + 0.0023 = -0.0023$  psi offset
5. Enter the new offset into memory.  
Send: `#*PW  
<cr><lf>`  
Next send the zero offset: `#*ZC  
<sp>-.0023  
<cr><lf>`  
The new offset of -0.0023 will now be added to all pressure readings of the CPT6010.  
Send: `#*SAVE  
<cr><lf>` to store the new value in non-volatile memory.
6. To check the zero correction:  
Send: `#*?  
<cr><lf>`  
The reading returned should be 0.0000 psi with both ports vented.

### 7.7.2 Absolute Zero Offset

Substitute the required password in place of “PW” in the following examples:

1. Find the current zero offset and make a note of the returned value.  
Send: `#*ZC?`<cr><lf> and record the reading.
2. Use the setup for absolute pressure shown in Figure 7.2. Apply a stable pressure value between 600 mTorr absolute and 20% of the transducer’s span. Measure the reference pressure reading in the native units of the CPT6010. This reading becomes the “true pressure”.
3. Clear the current zero offset from RAM.  
Send: `#*PW`<cr><lf>  
Next send: `#*ZC 0`<cr><lf>
4. Determine the current pressure reading.  
Send: `#*?`<cr> and make a note of this reading.
5. Subtract the current pressure reading from the true pressure (vacuum) reading.  
The difference is the zero offset now required.  
Example: For a 0-15 psia unit with 600 mTorr absolute pressure applied, using psi units:  
600 millitorr = 0.0116 psia (true pressure)  
Current pressure reading (from step 4) = -0.0011 psia  
True pressure – current pressure = new offset  
 $0.0116 - (-0.0011) = +0.0105$  psi offset
6. Enter the new offset into memory.  
Send: `#*PW`<cr><lf>  
Then send: `#*ZC<sp>.0105`<cr><lf>  
The new offset of 0.0105 will now be added to all pressure readings.  
Send: `#*SAVE`<cr><lf> to store the new value in non-volatile memory.
7. To check the zero correction:  
Send: `#*?`<cr><lf>  
For 600 mTorr the pressure reading returned should be 0.0116 psia.

## 7.8 Span Adjustment

The span adjustment procedure is the same for gauge and absolute units. Always make zero corrections before changing the span factor. A scale factor within the range of 0.9 to 1.1 is used as a multiplier to correct for span shifts.

1. Determine the current span scale factor and record the reading.

Send: `#*SC?<cr><lf>`

This reading can be used at some later date to detect a span change between calibrations.

2. To clear the current scale factor:

Send: `#*PW<cr><lf>`

Next send: `#*SC<sp>1<cr><lf>`

3. Apply a known true pressure equal to the span of the CPT6010. To determine the CPT6010 pressure reading:

Send: `#*?<cr><lf>` and make a note of this reading.

4. Divide the known true pressure by the CPT6010 pressure reading. The result is the required new span scale factor.

Example: For a 150 psi unit:

True pressure = 150.003 psi

CPT6010 pressure reading (from step 3) = 149.984 psi

True pressure / CPT6010 pressure = new span scale factor

$150.003/149.984 = 1.000127$

5. To enter the new span scale factor:

Send: `#*PW<cr><lf>`

Then send: `#*SC<sp>1.000127<cr><lf>`

Send: `#*SAVE<cr><lf>` to store the new value in non-volatile memory.

All future pressure readings returned by this CPT6010 will be multiplied by a scale factor of 1.000127 before they are transmitted over the bus.

6. To check the span reading:

Send: `#*?<cr><lf>`

The returned pressure value should be 150.003 psi, if the pressure has not changed.

**NOTES**



**Mensor**

201 Barnes Drive  
San Marcos, Texas 78666  
Tel: 512-396-4200  
Fax: 512-396-1820  
sales@mensor.com  
www.mensor.com



**WIKAI Alexander Wiegand SE & Co. KG**  
Alexander-Wiegand-Straße 30  
D-63911 Klingenberg / Germany  
Tel: +49 93 72/132-5015  
Fax: +49 93 72/132-8767  
CTSales@wika.de  
www.wika.de