

Pneumatic High Pressure Controller, Model CPC7000

EN



Pneumatic High Pressure Controller, Model CPC7000



Part of your business

Further languages can be found at www.wika.com

© 08/2017, Mensor, LP. All rights reserved.

Mensor is a registered trademark of Mensor, LP.

All other brand and product names are trademarks or registered trademarks of their respective companies.

Prior to starting any work, read the operating instructions!

Keep for later use!

Contents

1. General Information	7
1.1 Warranty	7
1.2 Radio Frequency Emission Notices	8
1.2.1 FCC Emission Notice	8
1.2.2 CE Emission Notice	8
1.3 Software License Agreement	8
1.4 Mensor Service Plus	8
1.4.1 After the Warranty	8
1.4.2 Calibration Services	8
1.4.3 Certifications and Accreditations	8
2. Short Overview	9
2.1 Features	9
2.2 Turning On	10
2.3 Front Panel	11
2.3.1 Power Switch	11
2.3.2 USB Port	11
2.4 Display	12
2.5 Scope of Delivery	12
3. Safety	13
3.1 Explanation of Symbols	13
3.2 Intended Use	13
3.3 Improper Use	14
3.4 Responsibility of the Operator	14
3.5 Personnel Qualification	14
3.6 Personal Protective Equipment	16
3.7 Labelling, Safety Marks	16
3.7.1 Product Label	16
3.7.2 Symbols	16
3.8 Warnings and Cautions	17
4. Transport, Packaging and Storage	18
4.1 Transport	18
4.2 Packaging and storage	18
5. Installation	19
5.1 Mounting	19
5.2 Rear Panel	19
5.2.1 Rear Panel	19
5.2.2 Supply Port	20
5.2.3 VENT PROP Port	20
5.2.4 VENT NO Port	20
5.2.5 Measure / Control Port	20
5.2.6 Vent Ref Port	20
5.2.7 Barometric Reference Port	20
5.2.8 Optional: Barometric Sensor Port	20
5.2.9 Remote Communication Connections	20
5.2.10 Power Up	20
6. Operation	21
6.1 General Operation	21
6.1.1 Setup Applications	21

0019104001D 10/2018 EN

6.1.2	Display Screen Features	21
6.2	Initial Setup.	22
6.2.1	Contact and Version Information Application	22
6.2.2	Language Selection	22
6.3	Application Selection and Parameter Inputs.	23
6.4	Applications	24
6.4.1	Home Applications	24
6.4.1.1	Range Hold/ Autorange	25
6.4.1.2	Control Setpoint	25
6.4.1.3	Units and Pressure Type	28
6.4.1.4	Bar Graph	28
6.4.1.5	Auxiliary Displays	29
6.4.1.6	Zero Button	29
6.4.1.7	Tare Button	30
6.4.1.8	Operating Mode Selection	31
6.4.2	Settings Application.	31
6.4.2.1	Languages	32
6.4.2.2	Brightness	32
6.4.2.3	Volume	33
6.4.2.4	User Base Units/ Base Units Multiplier	33
6.4.2.5	Barometer Units	34
6.4.2.6	Configuration	34
6.4.3	Control Settings Application	35
6.4.3.1	Control Limits	35
6.4.3.2	Stability Parameters	36
6.4.3.3	Rate Setpoint	36
6.4.3.4	Rate Stability Parameters	37
6.4.3.5	Vent Rate	37
6.4.3.6	Vent Limit	38
6.4.3.7	Control Volume	38
6.4.4	Display Settings Application	39
6.4.4.1	Reading Filter	39
6.4.4.2	Reading Resolution	40
6.4.4.3	Bar Graph	40
6.4.4.4	Cal Function	40
6.4.5	Remote Application	41
6.4.5.1	Remote Command Set	41
6.4.5.2	Remote Communication Settings.	42
6.4.6	Step Settings Application	43
6.4.6.1	Preset Steps.	44
6.4.7	Programs Application	45
6.4.7.1	Edit Programs	45
6.4.8	Favorites Application	47
6.4.9	Information Application	47
6.4.10	Troubleshooting Application	48
6.4.11	Digital I/O Application	49
6.4.12	Leak Test Application	50
6.4.13	Switch Test Application.	51
6.4.14	Burst Test Application	52
6.4.15	Service Application	53

- 6.4.16 Unlocked Service Application 54
- 7. Remote Operation 55**
- 7.1 Digital I/O 55
 - 7.1.1 Digital I/O Specifications 55
- 7.2 Remote Operating Parameters 56
- 7.3 Command Set. 56
- 7.4 IEEE-488 56
 - 7.4.1 IEEE-488.2 Commands 56
- 7.5 Ethernet. 56
- 7.6 Serial. 57
 - 7.6.1 Serial Cable Requirements 57
- 7.7 Mensor Command Set 58
- 7.8 Command and Query Format 58
- 7.9 Command Set Definitions 58
- 7.10 Output Formats 58
- 7.11 CPC7000 Commands and Queries 59
 - 7.11.1 Units Command Syntax for Measurement Units 66
 - 7.11.2 CPC7000 Error Codes 67
 - 7.11.3 SCPI Commands and Queries 67
 - 7.11.4 SCPI Commands Error Messages and Error Codes 70
- 8. Faults 71**
- 9. Maintenance and Recalibration 72**
- 9.1 Maintenance 72
 - 9.1.1 Beyond the Warranty 72
 - 9.1.2 Transducer Removal 72
 - 9.1.3 Barometric Sensor (optional) Removal 74
 - 9.1.4 Cleaning 74
- 9.2 Recalibration 75
 - 9.2.1 Calibration Services by Mensor or WIKA worldwide 75
 - 9.2.2 Environment 75
 - 9.2.3 Pressure Standards 75
 - 9.2.4 Media 75
 - 9.2.5 Setup. 76
 - 9.2.6 Calibration Data 77
 - 9.2.7 One Point Cal Application 77
 - 9.2.8 Two Point Cal Application 78
 - 9.2.9 Linearization 79
 - 9.2.10 Head Pressure 80
- 10. Dismounting, Return and Disposal 82**
- 10.1 Dismounting 82
- 10.2 Return 83
- 10.3 Disposal. 83
- 11. Specifications 84**
- 11.1 Measure Specification 84
- 11.2 Base Instrument 84
- 11.3 Approvals and Certificates 85
- 11.4 Dimensions in mm (in) 86
 - 11.4.1 Desktop 86
 - 11.4.2 19" Rackmount 86

0019104001D 10/2018 EN

12. Accessories	87
12.1 Barometric Reference Sensor	87
12.1.1 Gauge Pressure Emulation	87
12.1.2 Absolute Pressure Emulation	87
12.1.3 Emulation Mode Accuracy	87
12.1.4 Barometric Reference Calibration	87
12.2 Additional Transducers	87
12.3 19" Rackmount	88
12.4 Fittings	88
12.5 Pressure Booster.	88
13. Appendix	89
13.1 Measurement Units	89
13.2 Conversion Factors, PSI	90
13.3 Conversion Factors, Millitorr	91
13.4 Conversion Factors, Pascal	92

Declarations of conformity can be found online at www.wika.com.

1. General Information

- The CPC7000 pneumatic high pressure controller described in the operating instructions has been designed and manufactured using state-of-the-art technology. All components are subject to stringent quality and environmental criteria during production. Our management systems are certified to ISO 9001 and ISO 14001.
- These operating instructions contain important information on handling the instrument. Working safely requires that all safety instructions and work instructions are observed.
- Observe the relevant local accident prevention regulations and general safety regulations for the instrument's operating range.
- The operating instructions are part of the instrument and must be kept in the immediate vicinity of the instrument and readily accessible to skilled personnel at any time. Pass the operating instructions onto the next operator or owner of the instrument.
- Skilled personnel must have carefully read and understood the operating instructions prior to beginning any work.
- The general terms and conditions contained in the sales documentation shall apply.
- Subject to technical modifications.
- Factory calibrations / DKD/DAkkS calibrations are carried out in accordance with international standards.

■ Further information:

Mensor Corporation

- Internet address: www.mensor.com
- Relevant data sheet: CT 27.63
- Application consultant: Tel.: (+1) 512-396-4200
(+1) 800-984-4200 (USA only)
Fax: (+1) 512-396-1820
E-Mail: sales@mensor.com
tech.support@mensor.com

WIKA Alexander Wiengand SE & Co. KG

- Internet address: www.wika.de / www.wika.com
- Relevant data sheet: CT 27.63
- Application consultant: Tel.: (+49) 9372/132-5015
E-Mail: CTsales@wika.com

1.1 Warranty

All products manufactured by Mensor are warranted to be free of defects in workmanship and materials for a period of two year from the date of shipment. No other express warranty is given, and no affirmation of Seller, by words or actions, shall constitute a warranty. SELLER DISCLAIMS ANY IMPLIED WARRANTIES OF MERCHANTABILITY OR FITNESS FOR ANY PARTICULAR PURPOSES WHATSOEVER. If any defect in workmanship or material should develop under conditions of normal use and service within the warranty period, repairs will be made at no charge to the original purchaser, upon delivery of the product(s) to the factory, shipping charges prepaid. If inspection by Mensor or its authorized representative reveals that the product was damaged by accident, alteration, misuse, abuse, faulty installation or other causes beyond the control of Mensor, this warranty does not apply. The judgment of Mensor will be final as to all matters concerning condition of the product, the cause and nature of a defect, and the necessity or manner of repair. Service, repairs or disassembly of the product in any manner, performed without specific

1. General Information

factory permission, voids this warranty.

MENSOR MAKES NO WARRANTY OF ANY KIND WITH REGARD TO THIS MANUAL, INCLUDING, BUT NOT LIMITED TO, THE IMPLIED WARRANTIES OF MERCHANTABILITY AND FITNESS FOR A PARTICULAR PURPOSE. Mensor shall not be liable for errors contained herein or for incidental or consequential damages in connection with the furnishing, performance, or use of this material.

EN

1.2 Radio Frequency Emission Notices



USE SHIELDED CABLES TO CONNECT EXTERNAL DEVICES TO THIS INSTRUMENT TO MINIMIZE RF RADIATION

1.2.1 FCC Emission Notice

This equipment has been tested and found to comply with the limits for a Class A digital device, pursuant to part 15 of the FCC Rules. These limits are designed to provide reasonable protection against harmful interference when the equipment is operated in a commercial environment. This equipment generates, uses, and can radiate radio frequency energy and, if not installed and used in accordance with the instruction manual, may cause harmful interference to radio communications. Operation of this equipment in a residential area is likely to cause harmful interference in which case the user will be required to correct the interference at his or her own expense.

1.2.2 CE Emission Notice

This equipment is of the emission class A, intended for operation in industrial environments. It can cause interference under certain circumstances if operated in other environments, i.e. residential or commercial areas. In this case, the user may be asked to take appropriate measures to correct it.

1.3 Software License Agreement

This product contains intellectual property, i.e. software programs, that are licensed for use by the end user/customer (hereinafter "end user").

This is not a sale of such intellectual property.

The end user shall not copy, disassemble or reverse compile the software program.



The software programs are provided to the end user "as is" without warranty of any kind, either express or implied, including, but not limited to, warranties of merchantability and fitness for a particular purpose. The entire risk of the quality and performance of the software program is with the end user.

Mensor and its suppliers shall not be held to any liability for any damages suffered or incurred by the end user (including, but not limited to, general, special, consequential or incidental damages including damages for loss of business profits, business interruption, loss of business information and the like), arising from or in connection with the delivery, use or performance of the software program.

1.4 Mensor Service Plus

1.4.1 After the Warranty

Mensor's concern with the performance of this instrument is not limited to the warranty period. We provide complete repair, calibration and certification services after the warranty for a nominal fee.

1.4.2 Calibration Services

In addition to servicing our own products Mensor can perform a complete pressure calibration service, up to 20,000 psi, for all of your pressure instruments. This service includes an accredited calibration.

1.4.3 Certifications and Accreditations

Mensor is registered to ISO 9001:2008. The calibration program at Mensor is accredited by A2LA, as complying with both the ISO/IEC 17025:2005 and the ANSI/NCSL Z540-1-1994 standards.

0019104001D 10/2018EN

2. Short Overview

The CPC7000 pneumatic high pressure controller is a multi-range automatic pressure controller designed to test and calibrate a variety of pressure devices such as pressure gauges, pressure switches, sensors, transducers and transmitters in either absolute or gauge pressure modes. The CPC7000 can have up to three internal pressure reference transducers and an optional barometric reference for gauge or absolute emulation. The CPC7000 is available as a desktop or a rack mountable instrument.

EN



Figure 2.1 Desktop version

2.1 Features

Here is a short list of significant features designed into the CPC7000:

- Up to three removable / interchangeable, highly stable, temperature compensated, internal pressure transducers
- Operating pressure range from 0... 700 bar (0 ... 10,000 psi)
- 0.01% Intelliscale-50 accuracy
- Easily removable transducers from the front of the CPC7000 This facilitates “out of instrument” recalibration of individual transducers using the optional calibration sled
- An optional removable / interchangeable internal high accuracy barometric reference transducer providing gauge pressure emulation for absolute ranges and absolute pressure emulation for gauge ranges
- 8.9” color LCD display with touch screen
- Multiple languages; change the language for on-screen text and number/date formats by simply touching one of the “national flag” icons available in the setup screen.
- Desk top or rack mount
- Local operation, or command and read remotely

2. Short overview

2.2 Turning On

You can confirm that your CPC7000 is operational right now. Apply power to the power connector on the rear of the instrument with the included power cord, remove any plastic plugs from the rear panel pressure ports, and press the power switch to ON. The system will go through an initialization process, which takes about 30 seconds, and then a display will appear similar to the screen shown below



Earth Ground! Any power adaptors or surge protection devices that negate the protective earth ground should not be used. The power cord must be accessible and contain a protective earth ground. Do not position the equipment so that it is difficult to remove the power cord.



Ventilation! Do not block airflow to ventilating fans located on rear of instrument.

To see information about the configuration of your new CPC7000, touch the Next Page Button [▶] then the Information Application (App) icon [i] on the menu and a window will appear listing the Mensor contact information, model number and the transducers that are installed. Press the Previous Page Button [◀] then the Home App [🏠] to return to the main screen.



Figure 2.2 Information application

2. Short overview

2.3 Front Panel

The CPC7000 front panel includes an 8.9" color LCD display with touch screen. Operator input is accomplished by pressing the words or symbols and the App icons presented on the display. There is a single discrete on/off button and a USB on the right hand side. The front panel is hinged for easy access to remove or replace the transducers inside. The instructions for accessing the transducers are provided in Section 9.4 Transducer removal. The front panel also shows the model number designation and brand logos

EN



2.3.1 Power Switch

The power switch is a two-state device with an action similar to that of a ball point pen. Push the button with enough force to latch it in to turn the unit ON. Push it again to release it to turn the system OFF.



If power to the instrument is interrupted while ON it will shut down until the power is restored, then immediately resume operation

2.3.2 USB Port

The front panel USB port is the Host USB and is intended for future expansion or software upgrades.

2. Short overview

2.4 Display

The display is made up of two sections. In the main screen (“Home Application”), the left three fourths shows the operating screen displaying the active pressure reading, units, mode (absolute or gauge), active range of the internal transducer, pressure control setpoint, a bar graph (if enabled), an auto zero or tare button (if enabled) and any auxiliary displays that have been chosen. The right one fourth of the screen has Application Icons (“Apps”) for setting general instrument settings, control settings, display settings, program settings, favorites plus a “Next Page” button [▶] that, when pressed, shows a second and third page of icons for remote communication, troubleshooting, switch test, leak test, digital I/O and service applications.

EN



Buttons, Labels and Windows: The CPC7000 touch screen has many buttons with relevant graphic icons or text which, when touched, will open a related window where changes can be made or information viewed. Some of these buttons will toggle from one state to another, others present choices or display a numerical data entry screen. Text or icons that are displayed, but do not respond to being touched, are called labels or windows. Operators will quickly become accustomed to the particular characteristics of the frequently used buttons.

Main Screen: The main screen or “Home Application”, appears after power-up. This screen contains the operating screen and Settings application screen. It will remain as configured after a power cycle.

Operating screen: The operating screen (left 3/4 of the main screen) contains information relevant to the measurement. Up to three auxiliary displays can be shown simultaneously along with the current pressure value

2.5 Scope of Delivery

- Pneumatic high pressure controller model CPC7000
- Power cord with 1.5 m (5 ft) length
- Operating instruction
- Factory calibration certificate

Cross-check scope of delivery with delivery note.

0019104001D 10/2018EN

3. Safety

3.1 Explanation of Symbols

**DANGER!**

... indicates a directly dangerous situation resulting in serious injury or death, if not avoided.

**WARNING!**

... indicates a potentially dangerous situation that can result in serious injury or death, if not avoided.

**CAUTION!**

... indicates a potentially dangerous situation that can result in light injuries or damage to property or the environment, if not avoided.

**DANGER!**

... identifies hazards caused by electrical power. Should the safety instructions not be observed, there is a risk of serious or fatal injury.

**WARNING!**

... indicates a potentially dangerous situation that can result in burns, caused by hot surfaces or liquids, if not avoided.

**Information**

... points out useful tips, recommendations and information for efficient and trouble-free operation.

3.2 Intended Use

The CPC7000 pneumatic high pressure controller is designed to automate the testing and calibration of pressure devices and instruments for pressures up to 10,000 psi. Up to three removable / interchangeable pressure transducers are available in full scale (FS) ranges from 1500 to 10,000 psi (100 to 700 bar) gauge or absolute. Each transducer module is configured with its own calibration parameters on board and have 0.01% FS or optional 0.01% IS-50 uncertainty.

The three transducers, in combination with the special control valve regulator, provide a dynamic output. The operator can choose to control pressure either using a single, selected transducer or auto-range control across all three transducers. The three ranges can be chosen to optimize uncertainty levels across the full pressure span of the instrument.

In addition to the capacity for three active ranges, a fourth, barometric transducer is available as an option. With this option installed a CPC7000, with absolute or gauge pressure transducers, can emulate pressure of the opposite type.

The operational safety on the instrument is achieved with relief valves and blow out disks to ensure overpressure protection along with automatic venting of unused transducers.

**CAUTION!**

Instrument is intended to be used with pressure media Nitrogen (Class 2.8 or better) only.

3. Safety

EN



CAUTION!

Instrument is intended to be used up to a maximum altitude of 2,000 meters



CAUTION!

Instrument is intended to be used just indoors and in a dry environment



WARNING!

The pressurized volume of the device under test including any tubing and manifold should not exceed 100 cc.

This instrument is not permitted to be used in hazardous areas!

The instrument has been designed and built solely for the intended use described here, and may only be used accordingly.

The technical specifications contained in these operating instructions must be observed. Improper handling or operation of the instrument outside of its technical specifications requires the instrument to be taken out of service immediately and inspected by an authorised WIKA service engineer.

Handle electronic precision measuring instruments with the required care (protect from humidity, impacts, strong magnetic fields, static electricity and extreme temperatures, do not insert any objects into the instrument or its openings). Plugs and sockets must be protected from contamination.

The manufacturer shall not be liable for claims of any type based on operation contrary to the intended use.

3.3 Improper Use



WARNING!

Injuries through improper use

Improper use of the instrument can lead to hazardous situations and injuries.

- ▶ Refrain from unauthorised modifications to the instrument.
- ▶ Do not use the instrument within hazardous areas.
- ▶ Do not use the instrument with abrasive or viscous media.

Any use beyond or different to the intended use is considered as improper use. Do not use this instrument in safety or emergency stop devices.

3.4 Responsibility of the Operator

The instrument is used in the industrial sector. The operator is therefore responsible for legal obligations regarding safety at work.

The safety instructions within these operating instructions, as well as the safety, accident prevention and environmental protection regulations for the application area must be maintained.

The operator is obliged to maintain the product label in a legible condition.

To ensure safe working on the instrument, the operating company must ensure

- that the operating personnel are regularly instructed in all topics regarding work safety, first aid and environmental protection and know the operating instructions and in particular, the safety instructions contained therein.
- that the instrument is suitable for the particular application in accordance with its intended use.
- that personal protective equipment is available.

0019104001D 10/2018EN

3.5 Personnel Qualification



WARNING!

Risk of injury should qualification be insufficient

Improper handling can result in considerable injury and damage to equipment.

- ▶ The activities described in these operating instructions may only be carried out by skilled personnel who have the qualifications described below.

Skilled personnel

Skilled personnel, authorised by the operator, are understood to be personnel who, based on their technical training, knowledge of measurement and control technology and on their experience and knowledge of country-specific regulations, current standards and directives, are capable of carrying out the work described and independently recognising potential hazards.

Operating personnel

The personnel trained by the operator are understood to be personnel who, based on their education, knowledge and experience, are capable of carrying out the work described and independently recognising potential hazards.

Special knowledge for working with instruments for hazardous areas:

The skilled (electrical) personnel must have knowledge of ignition protection types, regulations and provisions for equipment in hazardous areas.

3. Safety

3.6 Personal Protective Equipment

The personal protective equipment is designed to protect the skilled personnel from hazards that could impair their safety or health during work. When carrying out the various tasks on and with the instrument, the skilled personnel must wear personal protective equipment.

EN



Wear safety goggles!

Protect eyes from flying particles and liquid splashes.



Wear safety shoes!

Protect feet from falling objects or objects lying around, as well as against toxic or hazardous liquids and aggressive media.

3.7 Labelling, Safety Marks

3.7.1 Product Label

①	Pneumatic high-pressure controller - CPC7000		
②	Instrument Serial number: 41XXXXXX Regulator Serial number: 30.XXX.XXX		
③	Power supply:	100-120/ 200-240V, 50/60Hz	③
④	Energy consumption:	max. 140 VA	
⑤	Pressure medium:	nitrogen	⑤
⑥	Operation temperature:	15 ... 45 °C	
⑦	Basic instrument:	0 ... 700 bar (0 ... 10.000 psi)	⑦
⑧	Date of manufacturing:	XX/XX/XXXX	

Mensor, 201 Barnes Drive, San Marcos, TX 78666, USA



- | | |
|--|-------------------------|
| ① Model | ⑤ Pressure medium |
| ② Serial number (Instrument and Regulator) | ⑥ Operating temperature |
| ③ Power supply | ⑦ Pressure rating |
| ④ Energy consumption | ⑧ Date of manufacturing |

3.7.2 Symbols



Before mounting and commissioning the instrument, ensure you read the operating instructions!



CE, Communauté Européenne

Instruments bearing this mark comply with the relevant European directives.

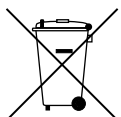

This marking on the instruments indicates that they must not be disposed of in domestic waste. The disposal is carried out by return to the manufacturer or by the corresponding municipal authorities (see EU directive 2012/19/

4. Transport, Packaging and Storage

EU).

3.8 Warnings and Cautions



WARNING!

HIGH PRESSURE! High pressure gases are potentially hazardous. Energy stored in these gases and liquids can be released suddenly and with extreme force. High pressure systems should be assembled and operated only by personnel who have been trained in proper safety practices.



WARNING!

NOT EXPLOSION PROOF! Installation of this instrument in an area requiring devices rated as intrinsically safe is not recommended.



WARNING!

POSSIBLE INJURY! The tubing, valves, and other apparatus attached to the gauge must be adequate for the maximum pressure which will be applied, otherwise physical injury to the operator or bystanders is possible.



CAUTION

USE THE PROPER PRESSURE MEDIUM! Use only clean, dry, nitrogen of class 2.8 or better unless otherwise specified by Mensor. This instrument is not designed for air use.



CAUTION

As with most sensitive electronic equipment, switch the power switch off before connecting or disconnecting to a power source to prevent data loss. Do not position the equipment so that it is difficult to disconnect the AC power cord.



WARNING!

Detachable main power supply cord delivered with inadequate ratings should not be used, it is recommended to use the power cord delivered with the instrument. See Section 11 Specifications for power ratings.

Additional Warning and Caution notices are found throughout this manual.

EN

4. Transport, Packaging and Storage

4.1 Transport

EN

Check the pneumatic high pressure controller model CPC7000 for any damage that may have been caused by transport. Obvious damage must be reported immediately.



CAUTION!

Damage through improper transport

With improper transport, a high level of damage to property can occur.

- ▶ When unloading packed goods upon delivery as well as during internal transport, proceed carefully and observe the symbols on the packaging.
- ▶ With internal transport, observe the instructions in chapter 5.2 "Packaging and storage".

If the instrument is transported from a cold into a warm environment, the formation of condensation may result in instrument malfunction. Before putting it back into operation, wait for the instrument temperature and the room temperature to equalise.

4.2 Packaging and storage

Do not remove packaging until just before mounting.

Keep the packaging as it will provide optimum protection during transport (e.g. change in installation site, sending for repair).

Permissible conditions at the place of storage:

- Storage temperature: 0 ... 70 °C
- Humidity: 35 ... 85 % relative humidity (no condensation)

Avoid exposure to the following factors:

- Direct sunlight or proximity to hot objects
- Mechanical vibration, mechanical shock (putting it down hard)
- Soot, vapour, dust and corrosive gases
- Hazardous environments, flammable atmospheres

Store the instrument in its original packaging in a location that fulfils the conditions listed above. If the original packaging is not available, pack and store the instrument as described below:

1. Wrap the instrument in an antistatic plastic film.
2. Place the instrument along with shock-absorbent material in the packaging.
3. If stored for a prolonged period of time (more than 30 days), place a bag containing a desiccant inside the packaging.

5. Installation

Personnel: Skilled electrical personnel



WARNING!
READ THESE INSTRUCTIONS BEFORE INSTALLATION!

Only use original parts (see chapter 11 “Accessories”).



CAUTION
Damage to the instrument

When working on open electrical circuits (printed circuit boards) there is a risk of damaging sensitive electronic components through electrostatic discharge.

- ▶ The correct use of grounded working surfaces and personal armbands is required.

5.1 Mounting

The instrument can be set up on a desk top or it can be rack-mounted. Rack mount hardware is optional on the CPC7000 (see Section Specifications 11 and Section 12 Options and Accessories).

The special transducers used in the CPC7000 are relatively insensitive to tilt and vibration. However to further assure stability and accuracy, avoid mounting the instrument on surfaces subject to excessive motor or machinery vibration

5.2 Rear Panel

Up to five pneumatic pressure ports are located across the bottom of the rear panel. The instrument with gauge transducers will have a reference and a pressure port. The instrument with absolute transducers will use the pressure port. In the upper left corner under the digital I/O connector is a M12 fitting, which is connected to the barometric reference sensor if installed. The connections for digital I/O - 1 & 2 are located on the top on left side of the ventilation fan. Positioned on the right side is the RS-232, Ethernet, IEEE- 488, USB device connections for communication, as well as a USB host connection and the 12 VDC power input.



Figure 5.2 Rear Panel

5.2.1 Rear Panel



WARNING!
The pressure connections must be installed according to the following instructions, observing the relevant regulations. The installation is to be performed by trained, authorized personnel, knowledgeable in the safety regulations for working on pneumatic/hydraulic systems



Up to 7 pressure connections are on the rear panel. Pressure connections that are not assigned are plugged.

5. Installation

5.2.2 Supply Port

EN

The pressure supplied to the pressure connection labeled "Supply" should be approximately the greater of 30 ... 50 bar (435 ... 725 psi) or 7-10% higher than the full scale of the highest pressure transducer installed in the controller.

5.2.3 VENT PROP Port

The pressure connection labeled "VENT PROP" is the port where the system pressure is vented to the atmosphere under certain conditions. Leave this port as is.

5.2.4 VENT NO Port

The pressure connection labeled "Vent NO" is the port where the system pressure is vented to the atmosphere under emergent conditions. Leave this port as is.

5.2.5 Measure / Control Port

The Measure / Control port (when in the Control mode) supplies pressure that is precisely controlled by the controller. In the Measure mode, a pressure applied to the Measure / Control port is measured by the internal transducers.

5.2.6 Vent Ref Port

The pressure connection labeled "Vent Ref" is the port where the not in use reference transducer pressure is vented to the atmosphere under certain conditions. Leave this port as is.

5.2.7 Barometric Reference Port

The barometric references port is available on gauge units that have transducers that are not sealed gauge units. For these units this port is available to connect to the reference side of the transducer. This port is normally left open to atmosphere but may be connected to a stable reference pressure. In an absolute pressure transducer this port is not used

5.2.8 Optional: Barometric Sensor Port

The Barometric Sensor port is connected to the optional internal barometer and should be left open to atmospheric pressure.

5.2.9 Remote Communication Connections

See Section 8, Remote Operation for connections and commands for operation over IEEE-488, Ethernet, USB or RS-232 ports.

5.2.10 Power Up

Apply power to the power connector on the rear of the instrument using the power adaptor included, and switch the power switch on the front of the unit ON. The instrument will go through an initialization process and system check. As soon as the system check is completed the system will default to a screen similar to the one shown in Section 6.1.2, Display Screen Features. The main measurement screen may be configured in many different ways but initially it will be in a default configuration. Subsequently, the unit will power up in the configuration that it was in when last powered off. Allow at least 15 minutes of warm up before performing critical pressure measurements.

Do not position the equipment so that it is difficult to remove the power cord. The instrument is not intended for connection of long-distance lines, i.e. lines within a building that are longer than 30 m, or that leave the building (including lines of outdoor installations).

6. Operation

6.1 General Operation

This section describes the procedures for operating the CPC7000 from the front panel. Instructions for operating the device remotely from an external computer are covered in Section 8, Remote Operation. By following the procedures provided in these two sections and Section 9.2, Recalibration, you can expect your CPC7000 to deliver maximum accuracy and dependability for many years of useful service.

6.1.1 Setup Applications

Configuration of the CPC7000 is achieved by changing settings accessed through the Application (“App”) buttons. Local operation is accomplished by observing the data presented in the display. The appearance and functionality of the display can be changed by pressing the App button for the related function. After an app has been chosen, a set of related parameters will appear on the left. After choosing one of these parameters, a set of selections related to that parameter will appear on the right or a data entry keypad. The desired selection or data can be entered here.

6.1.2 Display Screen Features

The screen shown below provides an overview of the features that may appear on the display after initialization. The left three fourths of the display contains the area where information is displayed (in this case the Home Application) and the right one fourth contains the selection icons for each application. A zero or tare button, bar graph and none or 3 of the 7 available auxiliary displays (Peak, Rate, Rate Setpoint, Uncertainty, Units, Digital I/O and Source Pressure) will appear in the Home App if activated. All of the CPC7000 screen features are described in more detail throughout this manual. The active App is represented with a light gray background color compared to the other Apps.



Figure 6.1.2 Display Screen Features

6. Operation

6.2 Initial Setup

Section 6.2.1 and 6.2.2 are provided first so that the operator can initially check the information screen to verify the installed components and to change the language if needed.

6.2.1 Contact and Version Information Application

EN



Navigate to additional Apps by pressing the Next Page button [▶] at the right bottom of the App buttons. This gives access to the second page of the App selection area. Press the Information App button [i] to display Mensor contact, installed transducers, installed regulator along with instrument and software version information

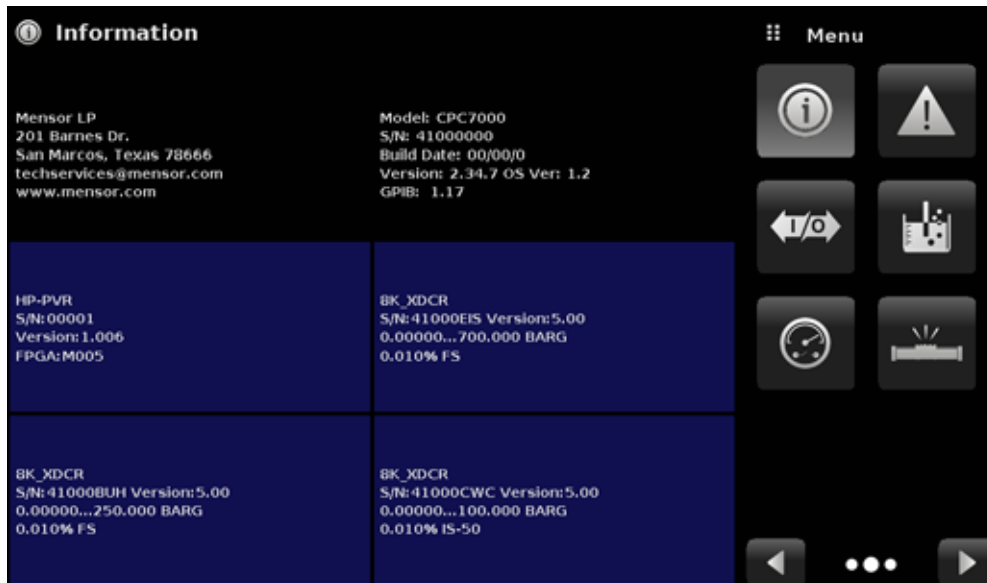

Figure 6.2.1 Information

6.2.2 Language Selection



Pressing the settings application button will open a screen where the language, display brightness, volume, user base units/multiplier and configuration loading/saving, can be changed. The current language selections available are shown in the table below. Additional language choices will appear on the screen after pushing the Next Page button [▶]:

Language	Country
English	USA
German	Germany
French	France
Spanish	Spain
Italian	Italy
Japanese	Japan
Chinese	China
Korean	Korea
English	Great Britain
English	Canada
French	Canada
Spanish	Latin America
Polish	Poland
Portuguese	Portugal
Portuguese	Brasil
Russian	Russia

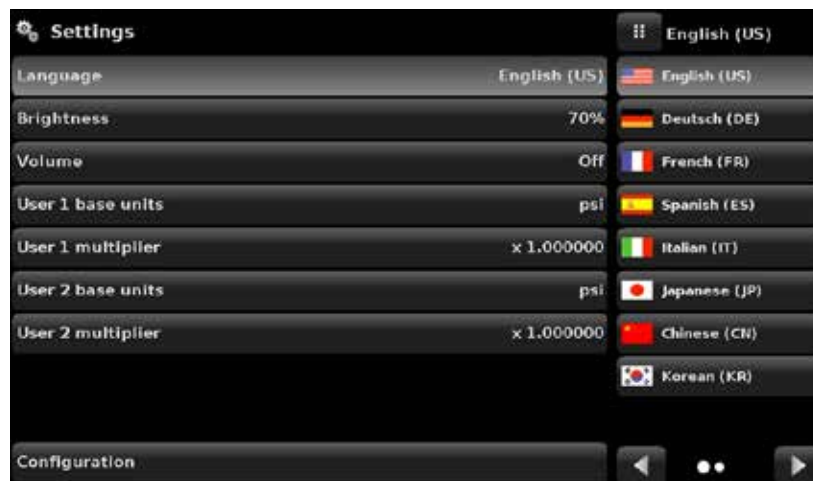

0019104001D 10/2018EN

6. Operation

6.3 Application Selection and Parameter Inputs

The application selection area on the right one fourth of the screen (see Figure 6.1 Display Screen Features) is the area where setup, information, calibration, service and other Apps can be chosen. Multiple pages of application selections can be accessed by pressing the Next Page button [▶] or by pressing the Previous Page button [◀]. A series of horizontally placed circles on the bottom right indicate the active page by a larger circle. As each App is chosen, related application parameters will appear on the left three fourth of the screen along with the name of the application, and a reduced size icon in the top title section. When a parameter is chosen, related selections, sliding scales or a data entry key pad will appear in the input area on the right where the application selection buttons were previously displayed. An example of each type of input is shown below. To return to the App selection menu, simply press the Menu button [☰] above the input area. The purpose and use of each selection and menu is intuitively apparent and will become second nature with minimal exposure to the menu structure.

EN

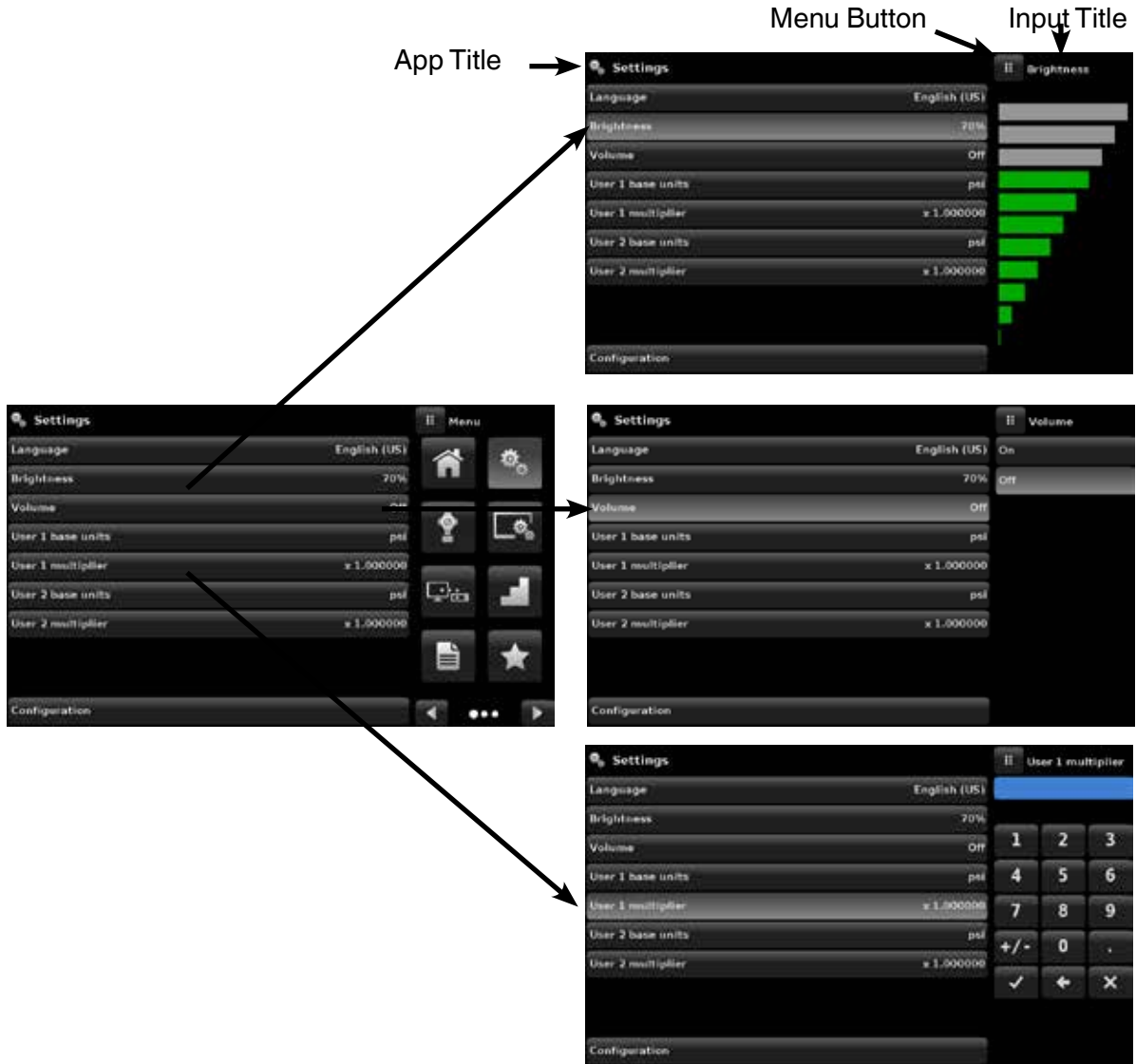

0019104001D 10/2018 EN

6. Operation

6.4 Applications

6.4.1 Home Applications

EN



The Home App is the normal operation screen. This application is different from the others in that it is not used to setup the configuration but is used to monitor the pressure applied to the installed transducers

The screen in Figure 6.4.1-A shows the basic Home App in an instrument. The user can change the display to show multiple auxiliary displays by pressing the auxiliary button on the left corner of the screen (Figure 6.4.1-B Home App With Auxilliary). The Units button is always displayed. When the Units button is pressed a selection of imperial and metric units will be displayed on the right (Figure 6.4.1-C Pressure Units); notice that the Units button has a lighter background when the selection menu is active. If a barometric reference is installed, the Mode button, described below, will toggle from Gauge to Absolute mode when pressed.



Figure 6.4.1-A Basic Home App



Figure 6.4.1-B Home App with Auxiliary Display



Figure 6.4.1-C Pressure Units

6. Operation

6.4.1.1 Range Hold/ Autorange

The Range Hold / Autorange button allows the user to select the active range of the transducers. By clicking the Range Hold button, the user can select the active transducer from the primary, secondary and tertiary transducers or utilize the “Autorange” feature to let the instrument automatically select the active range based on the current pressure value.



Figure 6.4.1.1 Range Hold Button

6.4.1.2 Control Setpoint

The Setpoint button allows the user to enter the desired pressure value to be controlled by the instrument. There are multiple ways of entering the control setpoint: numeric keypad, step increments, percentage entry, digital step or a program data entry. These methods can be accessed by the user by pressing the “Setpoint” button and the various setpoint entry methods can be navigated with the Next Page [▶] and Previous Page [◀] buttons.



Figure 6.4.1.2 Setpoint Button

6. Operation

6.4.1.2.1 Numeric Keypad

The first entry method provides 10 digits for numeric entry, plus the decimal point and a sign key (Figure 6.4.1.2.1 Numeric Keypad Setpoint Entry). The sign key [+/-] will toggle between positive and negative values. Each stroke on the key pad will echo in the blue input value window above the pad. A change between plus and minus values [+/-] can be entered at any time during the string entry. Pressing the Enter [✓] button will accept the value and it will become the setpoint. If the input window holds an illegal value when the Enter button is pressed the system will respond with an error tone and the entry will turn red. When that happens determine the cause of rejection, delete the entry using the Delete [✕] button and then enter a valid number. The setpoint can only be entered within the minimum and maximum control range set in the Control Settings App (6.4.3 Control Settings Application). These limits are shown above the numeric entry keypad.

EN



Figure 6.4.1.2.1 Numeric Keypad Setpoint Entry

6.4.1.2.2 Step Increments

The second entry method allows the user to enter the setpoint in the same way as the Numeric Keypad by keying in the value and then pressing Enter [✓] button. The user can then enter the desired value of step increment and press Step Up [▲] or Step Down [▼] button, without pressing the Enter button. This number will then be used to decrease or increase the existing setpoint value. Subsequent touches of the Step Up or Step Down button will continue to increase or decrease the setpoint by the step value. If the Enter [✓] button is pressed the newly entered value will register as a new setpoint value on the Home Screen rather than a step value.



Figure 6.4.1.2.2 Numeric Keypad with Step Increments

6. Operation

6.4.1.2.3 Percentage Entry

The third entry method is the Percentage Entry method (Figure 6.4.1.2.3-A Percentage Entry) which allows the user to select a setpoint value as a percentage of the pressure range of device under test (DUT). The user can choose between various percentage values by clicking on the desired button. The setpoint will instantly change to the selected percentage value of the DUT. The user can also configure the minimum and maximum pressure values of the DUT by clicking the button displaying pressure range. This would take the user to the Step Settings App (Figure 6.4.1.2.3-B Step Settings App) which is explained in Section 6.4.6 Step Settings Application.



Figure 6.4.1.2.3-A Percentage Entry



Figure 6.4.1.2.3-B Step Percentage

6.4.1.2.4 Digital Step Entry

The fourth entry method is the Digital Step data entry method. This method allows the user to increase or decrease the setpoint value by one digit at a time. The digit to be changed can be selected from a string of five zeroes (0) and one blue numeral one (1) by sliding a finger across the zeroes and converting the desired digit to a blue 1. The right most digit in the Digital Step corresponds to the least significant digit of the setpoint. Each digit of the setpoint can then be increased or decreased by pressing the Up [▲] or Down [▼] button.



Figure 6.4.1.2.4 Digital Step Entry

6. Operation

6.4.1.2.5 Program Data Entry

The fifth entry method is through the automated Programs stored in the CPC7000 memory. The Program Player allows the user to select one of the stored Programs and use it for setpoint entry. A Program can be chosen by using the Up [▲] or Down [▼] buttons. After selecting the desired program, press the Play [▶] button to start the program. More information on the Program Player and how to create/ edit programs is available in Section 6.4.7, Programs Application.

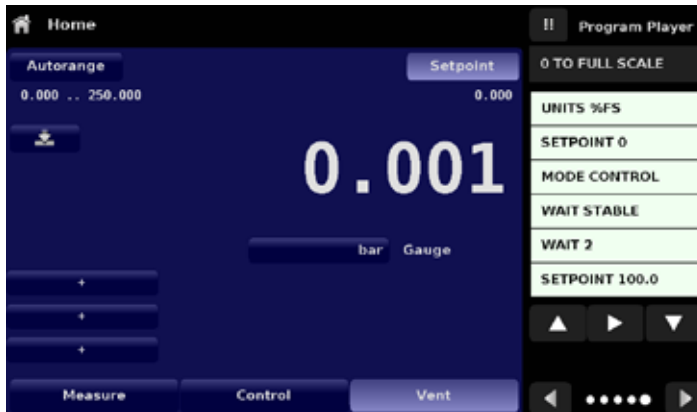

Figure 6.4.1.2.5 Program Data Entry

6.4.1.3 Units and Pressure Type

The Units button is always displayed. When the units button is pressed a selection of imperial and metric units will be displayed on the right (Figure 6.4.1.3-A). The Pressure Type button is only active if there is an optional Barometer installed. Otherwise, the Pressure Type button becomes a label (Figure 6.4.1.3-B) indicating the native mode of the instrument (absolute or gauge). When an optional barometer is installed, a native gauge transducer can emulate absolute pressure using the barometric reference. Alternatively, a native absolute transducer can emulate gauge pressure. Emulation can be activated simply by pressing the Pressure Type button

Pressure Units button



Figure 6.4.1.3-A Pressure units

Pressure Type button



Figure 6.4.1.3-B Pressure type

6.4.1.4 Bar Graph

An optional bar graph can be displayed below the current pressure value. The bar graph indicates the relative position of the current value within the maximum range of the primary transducer. This bar graph will appear in the Home App when selected from the Display Settings App (Section 6.4.4).

6. Operation

6.4.1.5 Auxiliary Displays

The screen in Figure 6.4.1.5-A shows all of the possible auxiliary display items that can be included in the Home App. The instrument can have up to three auxiliary displays which can be chosen by clicking on each button and then selecting the display item from the menu on the right side of the screen (Figure 6.4.1.5-B)



Figure 6.4.1.5-A Home App with Auxiliary Displays



Figure 6.4.1.5-B Auxiliary Display Selection

Some of the auxiliary display can be modified by pressing the displayed button. Others simply display auxiliary information.

- **Peak:** Pressing the Peak button will reset the upper and lower peak value to the current reading, subsequent negative or positive divergence from that reading will be recorded in the button.
- **Rate:** Pressing the Rate button will display a choice of time rate units for the rate denominator.
- **Rate Setpoint:** Pressing the Rate Setpoint button will let the user enter the new Rate Setpoint via the numeric Keypad ("Variable") or select "Slow" (.1% of the span of the primary transducer), Medium (1% of the span of the primary transducer), or "Fast" (10% of the span of the primary transducer).
- **Uncertainty:** Displays the accuracy at the pressure being displayed.
- **Units:** Pressing the Auxiliary Units button will display the same set of units available for the primary units. Pressing any of these units will change the auxiliary units to that chosen unit.
- **Digital I/O:** Displays the current state of digital inputs and outputs as "1" for high and "0" for low.
- **Source Pressure:** Displays the current source pressure at the supply port.

6.4.1.6 Zero Button

If the Zero Calibration function has been chosen in the Display Settings App (Section 6.4.4), then the Zero Cal Button [] will appear in the Home App. If the instrument is measuring absolute pressure, and the Zero Cal Button is pressed, a keyboard will appear to allow a single point calibration. If the instrument is measuring gauge pressure, pressing the button will set the current reading to zero. If the instrument is in emulation mode (absolute or gauge) then the value will not be saved to the transducer but only as a temporary adjustment while in emulation mode. After exiting the emulation mode or after a power cycle, the temporary adjustment will be cleared. The zero adjustment for an instrument not in emulation mode will be saved to the transducer as if single point calibration had been performed.

Figure 6.4.1.6 shows the zero cal function been enabled for instrument. The background color of the zero button will momentarily change to a lighter color as the zero calibration is performed then will revert back to a darker color when complete. The screen on the right shows this.

6. Operation

EN



Figure 6.4.1.6 Zero Button

6.4.1.7 Tare Button

If the Tare calibration function has been chosen in the Display Settings App (Section 6.4.4), then the Tare Button [**T**] will appear in the Home screen. For safety reasons, the tare button will be highlighted in yellow when active. The Tare button and the Zero Button cannot appear on the screen at the same time. When the Tare button is pressed, the instrument will subtract the current pressure reading (the tare pressure) so that the indicator will display zero. Subsequent deviations in pressure will be relative to the tare pressure.



Figure 6.4.1.7 Tare Button

Pressing the tare button again will deactivate the tare and change the pressure indication back to the reading corresponding to the calibrated output of the transducer. An active tare will revert to a deactivated state after a power cycle.



6. Operation

6.4.1.8 Operating Mode Selection

The operating modes are permanently displayed on bottom of the Home App. The CPC7000 has three operating modes: Measure, Control and Vent. After the system has switched on, the instrument will automatically be placed in Vent mode. The user can switch from one mode to the other by using the mode selection keys.



When switching from Control mode to Measure mode, the system will not be vented and the last applied pressure will be locked in the system by means of a solenoid valve

- **Measure Mode:** In Measure mode the CPC7000 acts like a precision pressure measuring instrument and measures the pressure applied at the Measure/Control port. If the Control mode was the last used mode before switching into Measure mode, the last controlled pressure is held in the test assembly.
- **Control Mode:** In Control mode the CPC7000 provides a controlled pressure at the Measure/Control port equal to the setpoint value. It is activated by pressing the Control button. In order to ensure smooth operation in the control mode, following measures must be taken and respective parameters must be set.
The control stability and the control rate can be set in the Control Settings App []
Control limits can be set in the Control Settings App []
- **Vent Mode:** The Vent function will vent the system to the atmosphere, including the test assembly connected to the Measure/Control port. The Vent mode can be activated from the Measure or Control mode by pressing the Vent button. The rate at which the pressure is released in vent mode is set in the Control Settings App []



WARNING!

Venting will cause a loss of pressure at the vent rate in the system and the plumbing connected to the Measure/Control port. Care must be taken that the device under test is not damaged during venting.

6.4.2 Settings Application



The Settings App is used to set up general settings for the display. Settings parameters include Language, Brightness, Volume, User 1 base units, User 1 multiplier, User 2 base units, User 2 multiplier, Barometer units, and Configuration. Figure 6.4.2 Settings application shows these parameters as indicated when the Settings App has been chosen. As each parameter is pressed, an input screen will appear on the right where selections can be made.

The Settings App provides a place to change the language, display brightness, volume, user units, and barometer units. Configuration settings of the unit can also be saved within this application plus the default configuration can be activated.

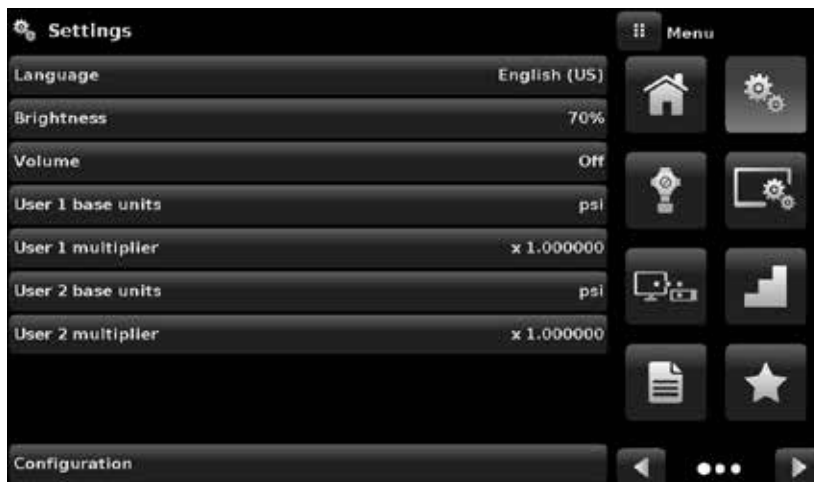

Figure 6.4.2 Settings App

6. Operation

6.4.2.1 Languages

The Language parameter provides a selection of different languages. Once a language is chosen all words within all menus will appear in the chosen language and the radix character (decimal mark) will change from a dot (.) to a comma (,) depending on the language chosen. More languages can be accessed by navigating to the next page of the language selection menu on the right side of the screen.

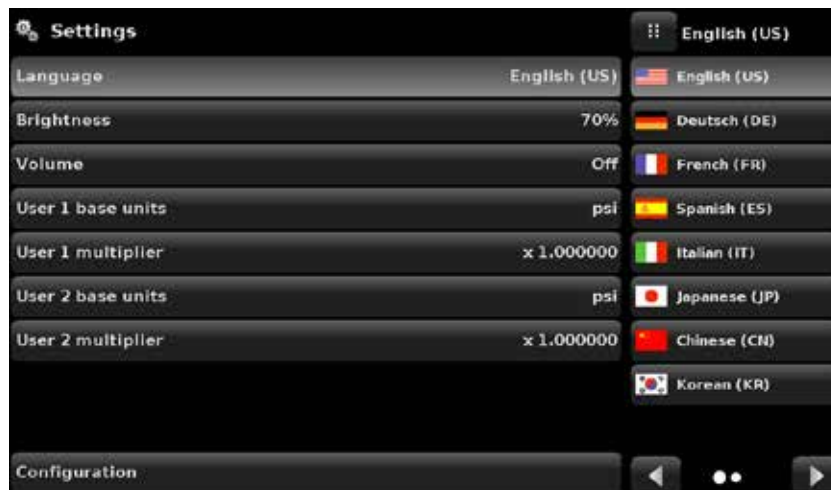

Figure 6.4.2.1 Languages

6.4.2.2 Brightness

The Brightness setting provides a sliding scale to increment the screen brightness in all screens. Sliding your finger along the bar graph or touching anywhere in the bar graph will change the brightness of the screen. After the setting is made and your finger is removed from the screen the menu will show the brightness percent selected and revert back to the main settings menu.

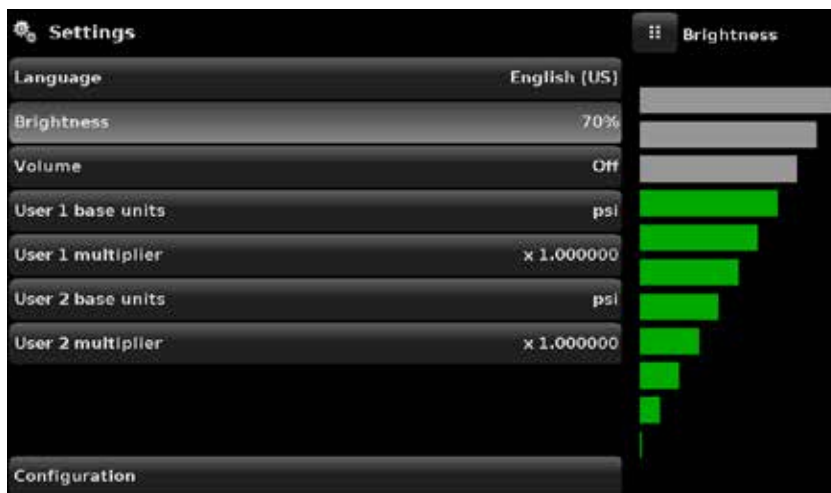

Figure 6.4.2.2 Brightness

EN

6. Operation

6.4.2.3 Volume

The Volume setting provides a way to turn on or off the touch screen audio feedback.

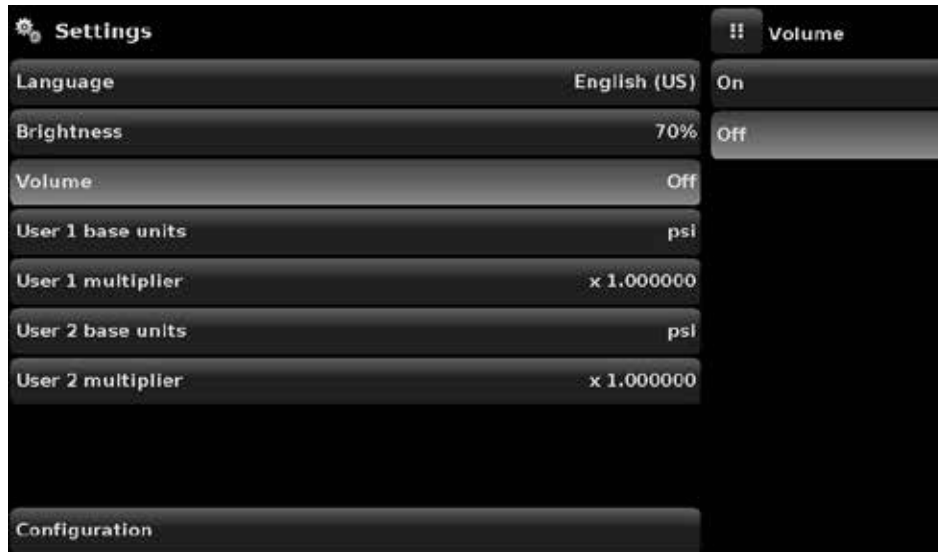

EN

Figure 6.4.2.3 Volume

6.4.2.4 User Base Units/ Base Units Multiplier

When choosing a unit of measure from the Home Application (main screen), standard units can be chosen in addition to two user defined units. User units 1 and 2 are defined in the Settings App using “User 1 base units”, “User 1 multiplier” and / or “User 2 base units”, “User 2 multiplier”. If the display of a special unit is needed, then a base unit should be chosen (psi, bar or Pascal) as the “User base unit” and the “User multiplier” can be entered to derive the special unit using the formula: Special unit = Base Unit x Unit multiplier. When set this way, and the user unit has been chosen from the main screen, then the user unit will now display the Special unit as derived.

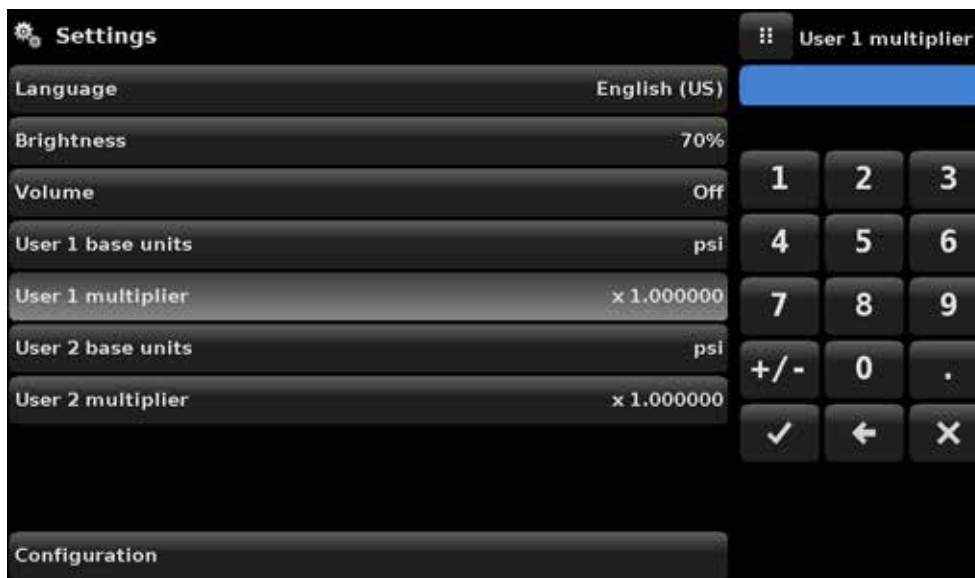

Figure 6.4.2.4 User base units/ Base units multiplier

6. Operation

6.4.2.5 Barometer Units

When the Barometer Units button has been chosen, a list of Imperial or Metric units is presented on the right side of the screen. Any of these units can be chosen from this list for the barometric readout. The barometric pressure readout can be seen on the bottom right of the Home App.

EN

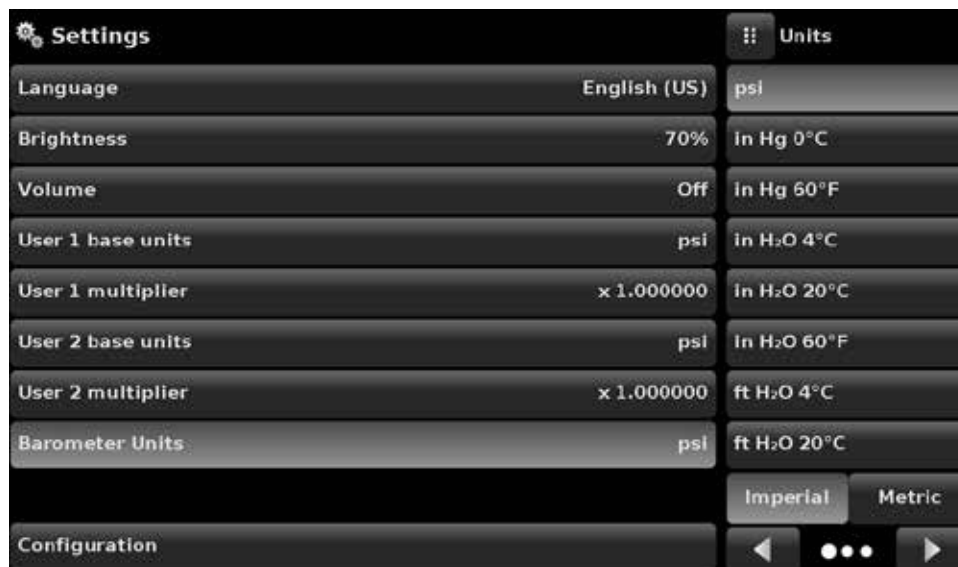

Figure 6.4.2.5 Barometer units

6.4.2.6 Configuration

Configuration is the last parameter in the Settings App. It allows the operator to save instrument settings and load them as a group, as needed, in the future. Configuration variables that are currently set in all Apps can be saved using the Configuration "Save" button and recalled using the Configuration "Load" button. Simply set all desired variables in each app, then go to Settings-Configuration, press one of the numbered Configuration buttons then press the "Save" button. This will save the current configuration in that button. To reload a saved configuration at a later time, go to Settings-Configuration and press the numbered configuration button corresponding to the saved configuration and then press the "Load" button.

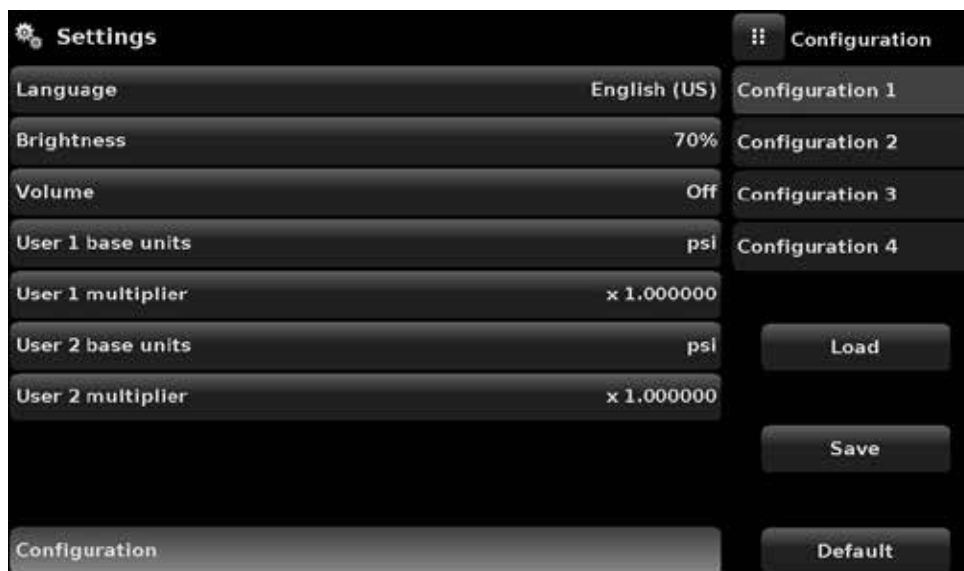

Figure 6.4.2.6 Configuration

The instrument default configuration can be activated simply by pressing the "Default" Button.

6. Operation

6.4.3 Control Settings Application



The Control Settings App allows the user to select and configure the control parameters for the instruments pressure regulating module (PVR module). Figure 6.4.3 shows the Control Settings Application screen.

EN

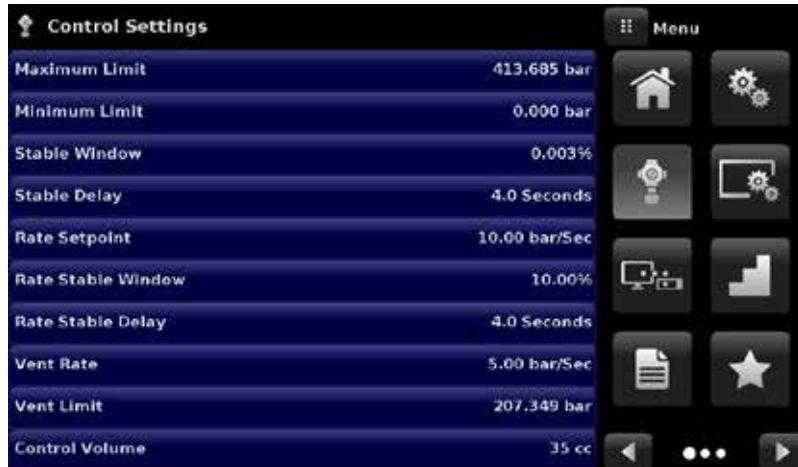

Figure 6.4.3 Control Settings App

6.4.3.1 Control Limits

The Maximum and Minimum Limit buttons in the Control Settings App provide a place to limit the set point value that can be chosen in the Home App. These limits can only be set within the range of the active transducer. When the instrument is in Autorange the limits can only be set within the range of the primary transducer which, by convention, will have the widest range. The minimum limit must be lower than the maximum limit. The user cannot enter set points and thereby not control to pressures outside of these limits. Figure 6.4.3.1 shows the data entry keyboard to enter the limits. Note that the keyboard displays the maximum value that can be entered.



Figure 6.4.3.1 Control limit setting

0019104001D 10/2018 EN

6. Operation

6.4.3.2 Stability Parameters

Stability parameters for the controlled pressure can be configured using the Stable Window and Stable Delay buttons. When the controller enters a stable condition the pressure indication color on the Home App will change from white to green. The Stable Window button allows the user to enter a value as a percentage of the highest range transducer. This value represents the pressure window within which any setpoint value would be considered stable by the user. The Stable Delay button lets the user add a desired delay until the pressure value is considered stable while being in the stable window.

EN

Stability
Parameters

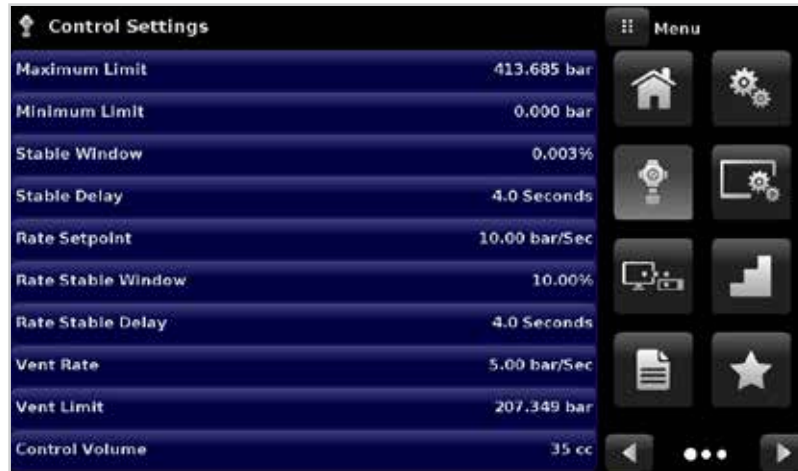

Figure 6.4.3.2 Stability Parameters

6.4.3.3 Rate Setpoint

The Rate Setpoint button allows the user to set the rate of pressure change when the CPC7000 is controlling up or down to a setpoint (Figure 6.4.3.3). The rate is limited from 1 bar/second to 10% of span of active range of the transducer / second upto a maximum of 10 bar/second.



Figure 6.4.3.3 Rate Setpoint

6.4.3.4 Rate Stability Parameters

Rate parameters for the control rate can be found in the Control Settings App and can be configured using the Rate Stable Window and Rate Stable Delay buttons. The Rate Stable Window button allows the user to enter a value as a percentage of the active range of transducer. This value represents the pressure window within which the control rate value would be considered stable by the user. The Rate Stable Delay button lets the user add a desired delay until the control rate is considered stable while being in the rate stable window.

Rate Stability Parameters

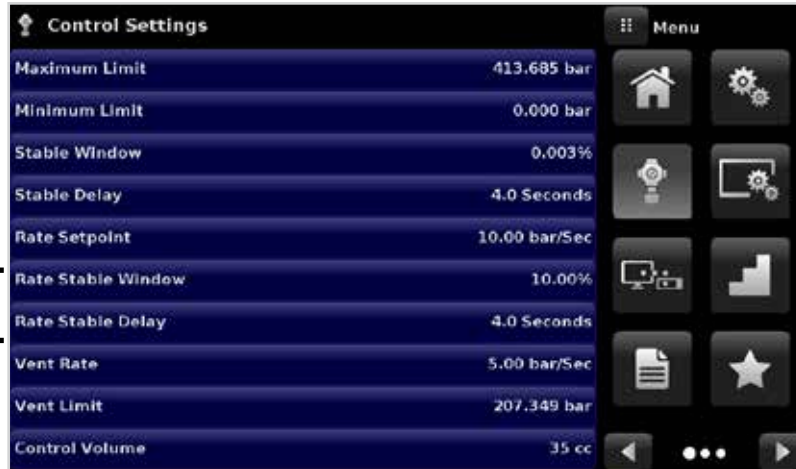

Figure 6.4.3.4 Rate Stability Parameters

6.4.3.5 Vent Rate

The Vent Rate button in the Control Settings App lets the user to determine the rate at which pressure will vent in vent mode. By default the rate of the vent is set similar to the control rate. Figure 6.4.3.5 displays the vent rate setting. The maximum allowable rate of vent is 60 bar/second and the minimum vent rate is limited to 1 bar/second.



Figure 6.4.3.5 Vent Rate

6. Operation

6.4.3.6 Vent Limit

This is the pressure at which controlled vent stops and the vent solenoid is opened causing the pressure to vent through the vent NO port uncontrolled. The vent limit can be set within the values of the primary transducer.

EN



Figure 6.4.3.6 Vent Limit

6.4.3.7 Control Volume

The Control Volume button in the Control Settings App allows the user to set the control pressure volume in cubic centimeters (cc) between 0 ... 50 cc. By default this is set to 25 cc. Figure 6.4.3.7 displays the control volume setting for the instrument.

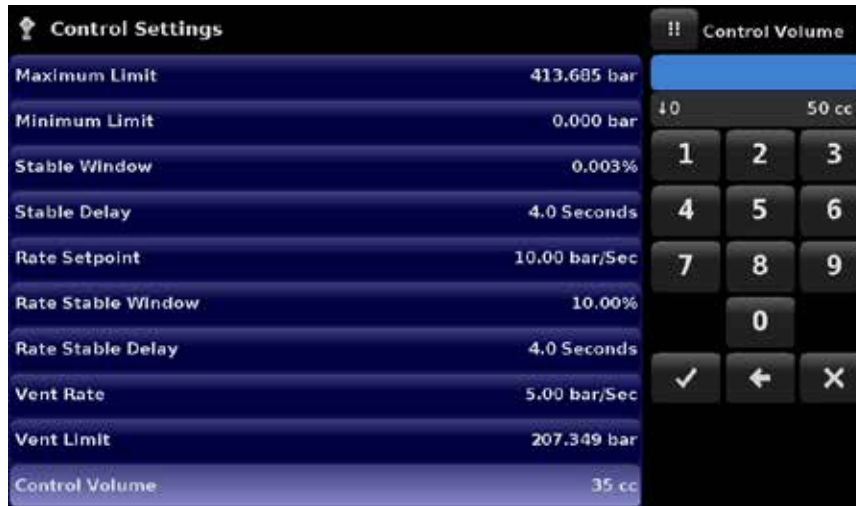

Figure 6.4.3.7 Control Volume

6. Operation

6.4.4 Display Settings Application



The Display Settings Application allows the user to configure display properties like the filter for the reading to reduce fluctuations due to electrical noise, and to set the resolution of the reading. In addition, the bar graph display and calibration function can be specified here.

EN



Figure 6.4.4 Display Settings App

6.4.4.1 Reading Filter

The Filter is an electronic filter to smooth out the pressure readings. Because of differences in resolution, greater filtering may display a more stable reading for some pressure units. Turn off the Filter by selecting “Off”, select varying degrees of filtering for the current units by selecting “Low”, “Normal” or “High”.



Figure 6.4.4.1 Reading Filter

6. Operation

6.4.4.2 Reading Resolution

The Resolution of the displayed pressure value can be set in the Display Settings Application using the resolution Parameter. The resolution can be set to 4, 5 or 6 digits.

EN





Figure 6.4.4.2 Reading Resolution

6.4.4.3 Bar Graph

The Bar Graph visible on under the displayed pressure value can be turned on/off in the Display Settings Application. The bar graph indicates the relative position of the current value with the maximum range of the primary transducer.

6.4.4.4 Cal Function

The Cal Function presents a choice of None, Tare or Zero. Choosing Zero will enable the Zero Cal Button [] in the Home App. Choosing Tare will enable the Tare Button [] in the Home App. The Tare button and the Zero Button cannot appear on the screen at the same time. See Section 6.4.1.6 and 7.4.1.7 for operation of the Zero and Tare buttons in the Home App (main screen).

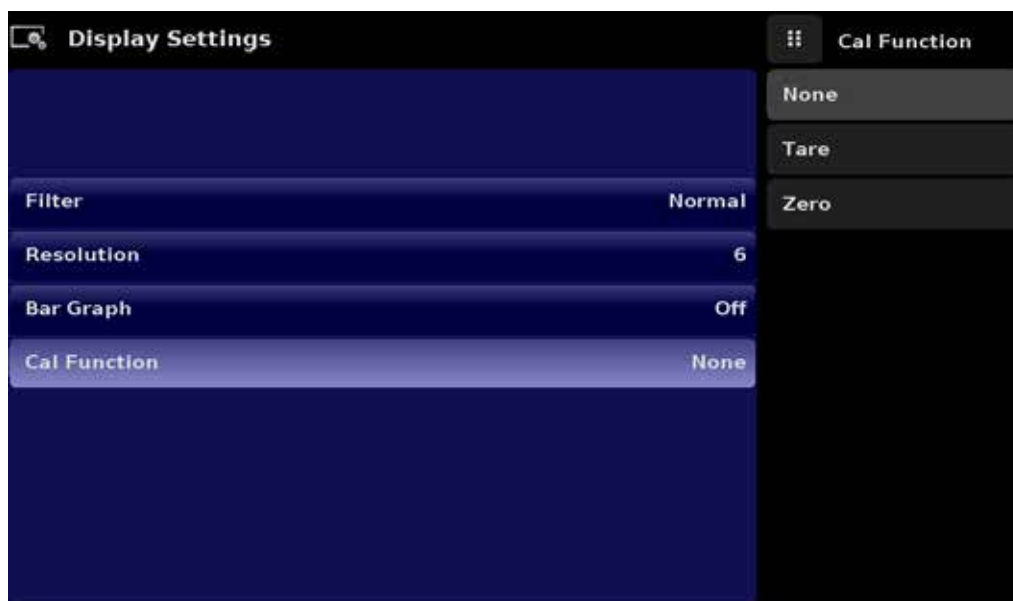

Figure 6.4.4 Cal Function

0019104001D 10/2018EN

6. Operation

6.4.5 Remote Application



With the Remote Settings application users can select the remote command set for all interfaces. The GPIB address, Ethernet network parameters and Serial parameters can also be set here. Details about the Remote Operation (command sets, cable requirements, etc.) can be found in Section 8, Remote Operation.

EN



Figure 6.4.5 Remote App

6.4.5.1 Remote Command Set

The remote command set parameter provides a choice of the Mensor command set or the WIKA SCPI command set (Figure 6.4.5.1-A). All sets of commands are listed in Section 8, Remote Operation. The termination character sets the output termination character for all remote communication command sets (Figure 6.4.5.1-B).



Figure 6.4.5.1-A Remote Command Set

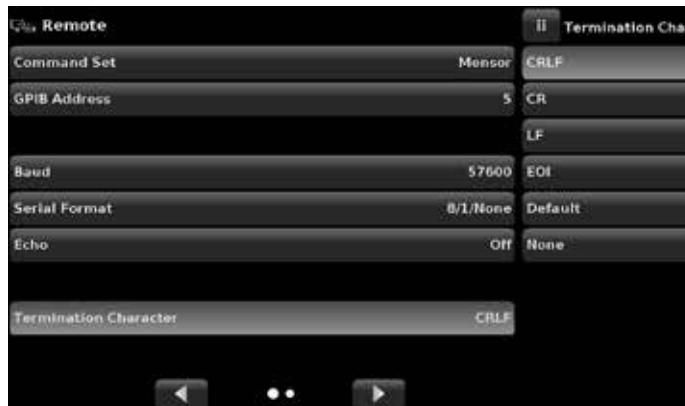

Figure 6.4.5.1-B Termination Character

0019104001D 10/2018 EN

6. Operation

6.4.5.2 Remote Communication Settings

The remainder of the Parameters in the Remote Application present the choice of a numeric entry, a numeric address entry, or a radio button selection. The parameters that require a numeric entry will present a numeric keypad with min and max limits for the variable. The parameters that require a numeric address (for example an IP address) will also present a keypad. Address entries should conform to the format of the parameter selected. The three screens below show examples of each type.

EN



Numeric entry



Numeric address entry

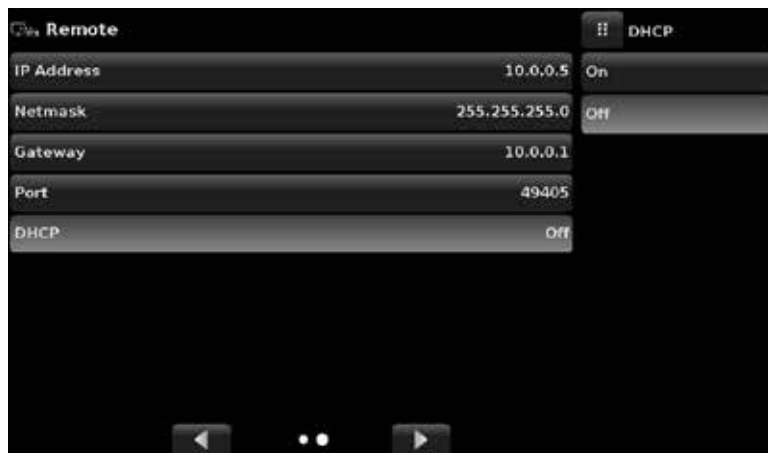

Radio button selection



Setting the Ethernet DHCP to yes will have a short delay while the DHCP server is contacted. If a DHCP server is not found, an error will be indicated. If DHCP is enabled, the IP address, Netmask and Gateway are greyed out and locked, these are controlled by the DHCP server.

6. Operation

6.4.6 Step Settings Application



The Step Settings Application allows the user to enter the minimum and maximum pressure values of the device under test (DUT) and the number of preset steps required across the span. From this information the Step Settings App will automatically calculate setpoint values in pressure units and values as a percentage of the full span of the DUT (Figure 6.4.6).

To enter the minimum and maximum range of the DUT select the DUT Maximum Range and DUT Minimum Range buttons (Figure 6.4.6-A) and enter the values. These ranges should be within the maximum range of the primary transducer. CPC7000 automatically switch between Pressure units and Percent of DUT Range values by pressing the units button or the percent button (Figure 7.4.6 - B). The user can be directed to this application from the setpoint entry method in the Home App (Section 6.4.1.2). The Overrange button allows an entry above 100% in order test for hysteresis on a dial gauge.

EN



Figure 6.4.6 Step Settings App



Figure 6.4.6-A DUT Range Selection



Figure 6.4.6-B Percent or Unit Selection

6. Operation

6.4.6.1 Preset Steps

The user can have up to 12 different points along the range of the device under test (DUT). The Preset Steps button allows the user to enter the number of points and then automatically divides the range in equivalent percentages. For example if the user needs 5 distinct points along the DUT range then enter 5 in the numeric keypad and press Enter [] button. CPC7000 will create setpoints at 0%, 25%, 50%, 75% and 100% of the DUT range (Figure 6.4.6.1-A). The user also has the option of changing these percentage values or adding additional values as needed by clicking on the individual Percentage button on the Step Settings app. The user can enter any percentage between 0 and 100. The desired value can then be chosen by checking the box [] beside the Percentage button.

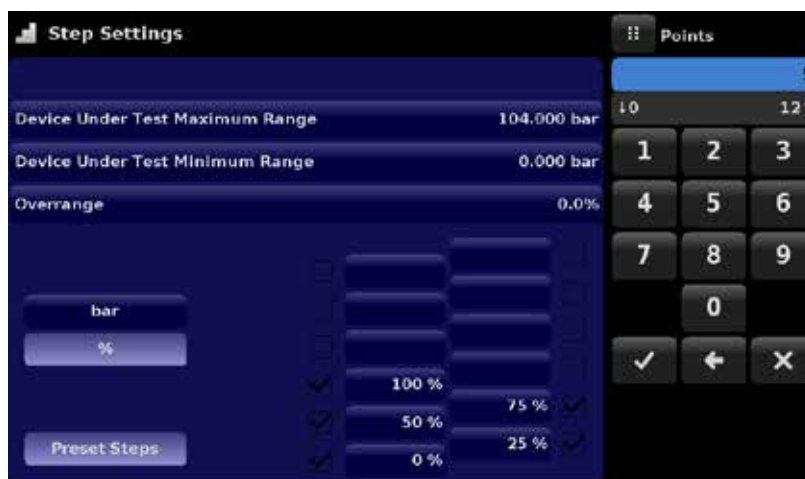

Figure 6.4.6.1-A 5 Preset Steps



Figure 6.4.6.1-B Percentage Value Added - 90%

EN

6. Operation

6.4.7 Programs Application



The Programs Application is used to create, view and edit programs that are used to automatically run a sequence of commands within the CPC7000. The Programs App screen displays the contents of the first written program in read only mode by default (Figure 6.4.7-A). User can load, edit and delete other saved and predefined programs by clicking on the title of the current program and then selecting the desired program sequence from the sidebar (Figure 6.4.7-B).

EN



Figure 6.4.7-A Programs App



Figure 6.4.7-B Programs Selection

6.4.7.1 Edit Programs







By default the programs are available in read only mode to prevent accidental changes to existing programs. The users can edit existing programs or create steps in new ones by clicking on Edit Program [] button (Figure 6.4.7.1-A). This makes the program editable and also activates the Insert [] and Delete [] buttons which are otherwise just labels and can't be clicked by the user. A series of predefined commands can be chosen to write the steps of a program. Selection of commands and data in each sequential line will create a draft of resulting command sequence in the selected program (Figure 6.4.7.1-B). Upon exiting the edit mode by pressing the Edit Program [] button, the system will ask "Save changed programs?" Pressing the [] button will accept the changes, pressing the [] will revert back to the old program. A list of available commands, data values and their functions are listed in Table 6.4.7.1.



Figure 6.4.7.1-A Editable Programs



Figure 6.4.7.1-B New Line Creation

6. Operation

Table 6.4.7.1 - Sequence Commands

Command	Function (data selection)
EN RANGE	Sets the active range
WAIT	Waits for a manual input or stable condition (Stable or Input)
DELAY	Delays for time = 1 to 3600 seconds (Numerical Entry)
MODE	Sets the control mode (Measure, Control or Vent)
UNITS	Sets the units for the active channel
PTYPE	Sets the pressure type (Gauge or Absolute)
SETPOINT%	Sets the control setpoint in % of current range (Numerical Entry)
SETPOINT	Sets the control setpoint for the instrument (Numerical Entry)
STEP%	Increases or decreases the current setpoint by the percent full scale specified
STEP	Increases or decreases the current setpoint in current units (Numerical Entry)
RSETPT	Sets the rate setpoint in current units (Numerical Entry)
SEQZERO	Set the zero for the current active transducer
SEQSTART	Starts the sequence from the beginning (None)
RUNITS	Sets the rate denominator time unit (min or sec)

6. Operation

6.4.8 Favorites Application



The Favorites Application is used to select programs that will appear in the Home App when the Favorites [] is pressed. The purpose of the Favorites App is to provide quick access to frequently used programs. The current list of favorites is shown in Figure 6.4.8 and the desired program can be run by clicking on its name which takes the user to the Programs App.

The list of favorites can be edited by clicking on the Play [] button. The list of programs in the Favorites App can be chosen by clicking a program from the list on the left and replaced by clicking a predefined or saved programs shown on the right side of the screen. A maximum of eight programs can be stored as favorites.



Figure 6.4.8 Favorites App

6.4.9 Information Application



The Information Application displays information about the instrument, including:

- Address, and email.
- Model number, serial number and operating software version.
- Regulator model number, serial number and software version.
- Transducer model numbers, serial number, range and software version.



Figure 6.4.9 Information App

6. Operation

6.4.10 Troubleshooting Application

EN



The Troubleshoot Application can be found by navigating to the second page in Apps section by clicking on the Next Page [] button. The Troubleshoot App will display information about error conditions and remote communications. Within the troubleshoot screen (Figure 6.4.10-B), push the Error button to display any errors that have occurred in the instrument due to a communication or network error. Push the Remote button to show commands and responses that have been sent over the remote communication connection.

If there are any errors in the error queue an error symbol [] will appear in all screens (Figure 6.4.10-A) of the instrument. Pressing this error button from any screen will open the Troubleshoot application where the error can be viewed.



Figure 6.4.10-A Error Indication



Figure 6.4.10-B Troubleshoot Screen

6. Operation

6.4.11 Digital I/O Application



The Digital I/O Application provides the user a place to assign conditions or actions to the digital inputs and the digital outputs, the default screen will show all inputs. The output screen can be reached by clicking on the Next Page [▶] button. By default both the inputs and outputs would be turned “off”. The instrument has six inputs and six outputs. Each input can be assigned by clicking on the name of the input and then selecting one of the options listed on the right. The logic of the switch can be reversed by pressing the Invert Logic (Yes/No) button. When a digital signal (switch closure) is sent to either of the input terminal on the back panel of the CPC7000, the instrument will perform actions based on the options assigned to the input.

- Measure Option: Will put the instrument in “Measure” mode
- Control Option: Will put the instrument in “Control” mode
- Vent Option: Will put the instrument in “Vent” mode
- Keylock Option: Will lock out the touch screen interface preventing local operation
- Start Option: Will start the most recent program selected in Favorites App
- Reading Option: Will send current pressure reading on the RS-232 communication port



Figure 6.4.11 Digital Input and Output App

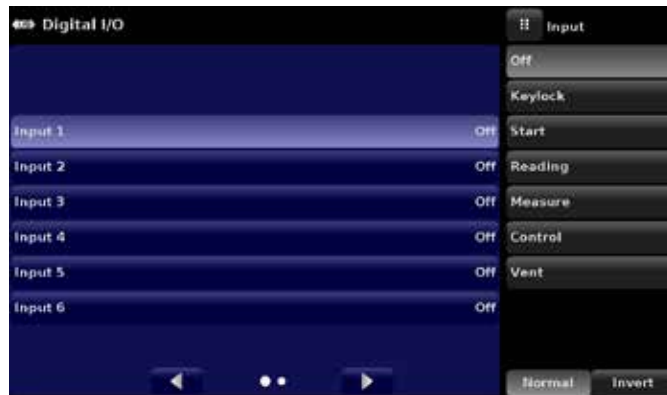

Figure 6.4.11-A Digital Input Assignment



Figure 6.4.11-B Digital Output Assignment

Each output can be assigned by clicking on the name of the output and then selecting one of the options listed on the right. The output switch is energized when the assigned instrument mode is active. The assigned output switch would be de-energized when the assignment is inactive.

- Stable option: Output energized when instrument reading is stable

6. Operation

6.4.12 Leak Test Application



Leak test on a pressure line or device under test can be performed by the user with this application. The user defines a leak by setting the Dwell Delay and the Dwell Time, Delta and Setpoint parameters. The leak test is initiated by pressing the Start button.

- Dwell Delay: The amount of time that the controller remains at the Setpoint before the test begins.
- Dwell Time: The amount of time that the controller is monitoring the pressure change.
- Delta: The change in pressure during the test that determines a pass or fail result.
- Setpoint: The controlled pressure at which the test begins.

If the change in pressure exceeds the Delta parameter before the allotted time in the Dwell Time parameter, then the Leak Test App will return a red status indication showing initial, final and the actual difference (Delta) in pressure recorded, and indicate a “failed” test. Otherwise it will return a green status indication showing that the delta was not exceeded for the Dwell Time, indicating a “passed” test. See Figure 6.4.12-A for examples of a failed and a passed test.



Figure 6.4.12 Leak Test App



Figure 6.4.12-A Leak Test Fail (left) and Pass (right)

EN

6. Operation

6.4.13 Switch Test Application



The Switch Application provides a place to test pressure switch actuation / deactuation points. Up to three switches of the same range can be tested at once. The Switch electrical power should be within the parameters given in Section 7.1.1 - Digital I/O Specifications. The Switch electrical connection should be in accordance with the Figure 6.4.13-A on the Digital I/O connector one. The Switch Application is not supported on the Digital I/O connector two.

EN

The Switch Test App has parameters that are used to setup the test:

- High Point: The highest pressure that the controller will control to during the test and should be set at a value above the point where the switch is expected to actuate
- Low Point: The pressure point below the value where the pressure switch is expected to actuate. It is also the point where the Controller switches from Fast Rate to Slow Rate.
- Fast Rate: the rate at which the controller will control pressure to the Low Point.
- Slow Rate: The rate at which the controller will control between the Low Point and the High point.

The Switch Test is initiated by pressing the start button.



Figure 6.4.13 Switch Test App

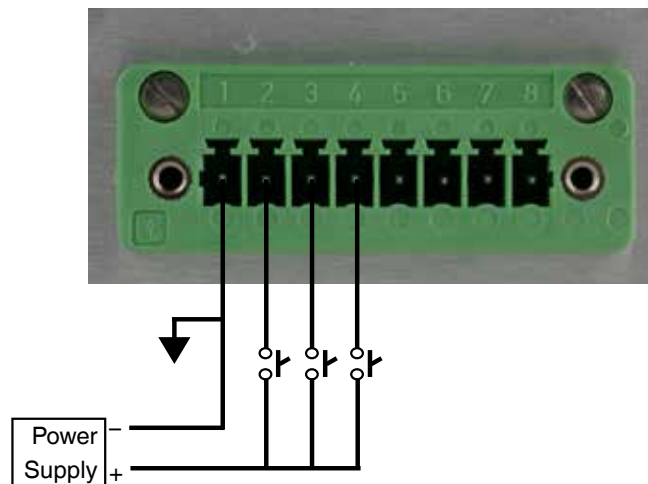

Figure 6.4.13-A Switch Test connections on Digital I/O Connector 1

6. Operation

6.4.14 Burst Test Application



The Burst Test Application tests the burst pressure of an external device. A device such as a rupture disk or any device that must be tested for burst pressure can be connected to the Measure / Control port. Enter the Parameters below then press start to initiate the test.

- High Point: The highest pressure that the controller will control to during the test and should be set at a value above the point where the burst pressure is expected to be.
- Low Point: The pressure point below the value where the burst pressure is expected to be. It is also the point where the controller switches from Fast Rate to Slow Rate.
- Fast Rate: the rate at which the controller will control pressure to the Low Point.
- Slow Rate: The rate at which the controller will control between the Low Point and the High point.

If the Device under test must experience a burst condition between the Low Point and the High Point the instrument will indicate the burst point at the end of the test. If the device under test does not experience a burst condition the burst test screen will indicate a complete status. The burst test is initiated by pressing the Start button. Figure 6.4.14-A and 7.4.14-B show the different status messages during a burst test.



Figure 6.4.14-A Burst Test App



Figure 6.4.14-B Burst Test Complete (No Burst)

EN

6. Operation

6.4.15 Service Application



The service application is a password protected area where calibration of all connected transducers can be accomplished. In addition, this is where the password for entering this area can be changed.

EN

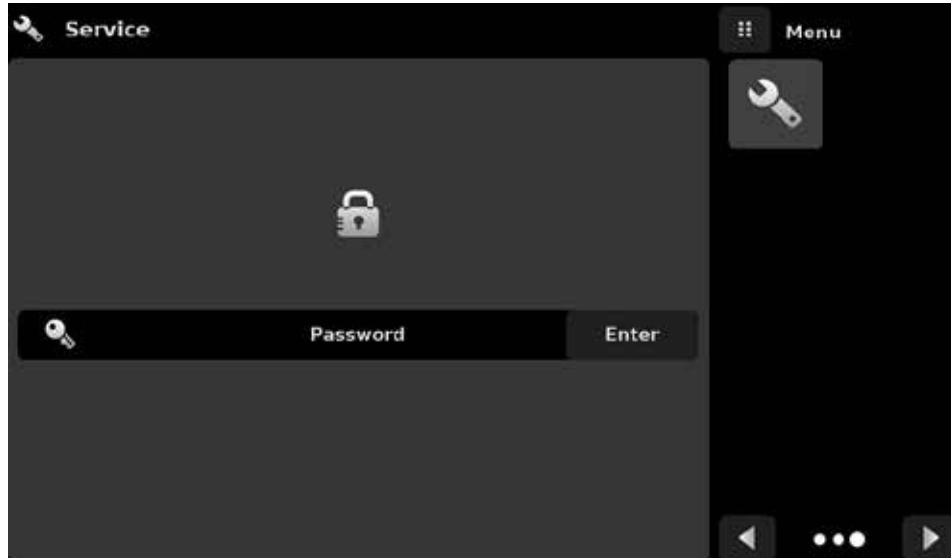



Figure 6.4.15-A Service App (Locked)

Press the Enter button to show the numeric keypad to enter a password. This will unlock other applications. Default password is 123456. Enter 123456 and press the check mark [] to unlock the Service Application.

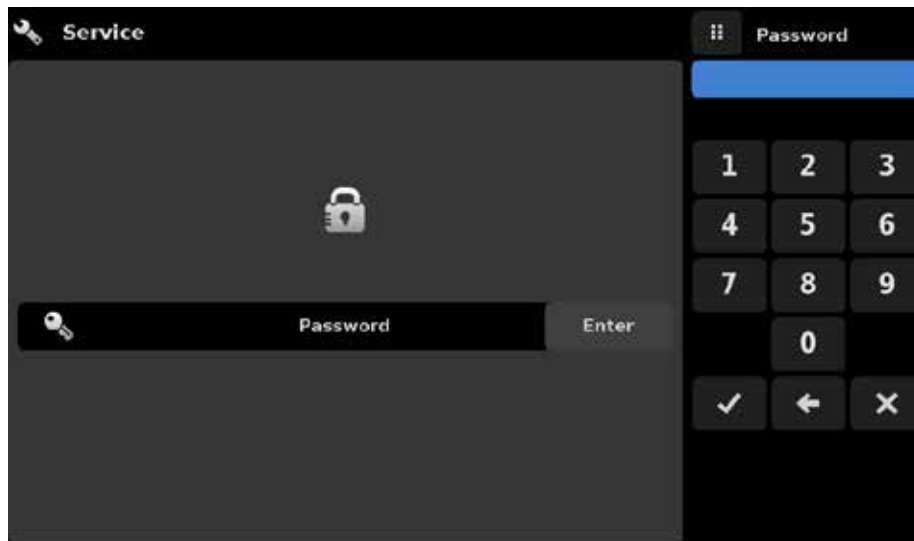

Figure 6.4.15-B Service App (Enter Password)

0019104001D 10/2018 EN



Note: The default password is 123456. After entering this for the first time, the password can be changed.

6. Operation

6.4.16 Unlocked Service Application

After the Password has been entered, the unlocked Service Application will appear (Figure 6.4.16). To re-lock this screen, press the lock button.

EN

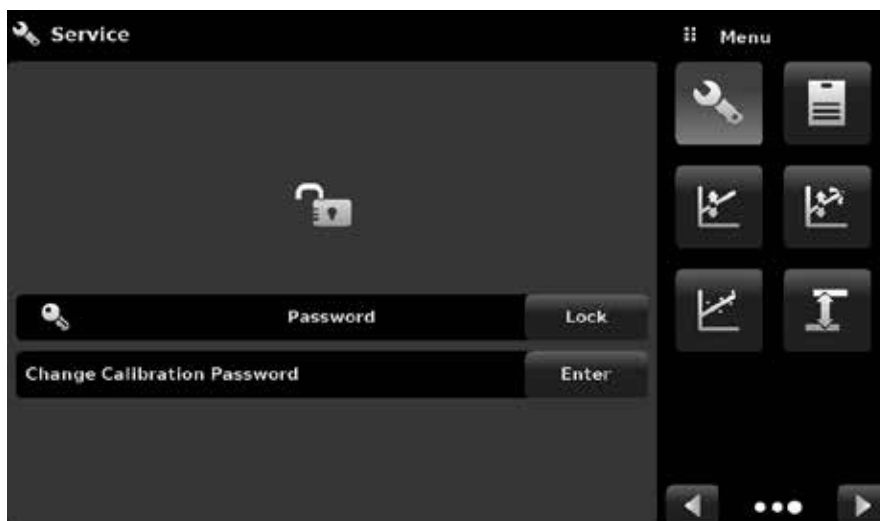

Figure 6.4.16 Unlocked Service App

From the Unlocked Service Application, the Password can be changed by pressing the Enter button next to the Change Password label. This will open a keypad where a new password can be entered and accepted by pressing the Check Mark [].



Note: Please make note of a password change and save the new password in a secure location.

The Unlocked Service Application is the access point to all calibration screens described in Section 9 of this manual.



Note: Recommended calibration setup and explanation of calibration screen applications is covered in Section 9 of this manual.

7. Remote Operation

7. Remote Operation

7.1 Digital I/O

Use Screens in Section 6.4.11 Digital I/O Application to assign conditions or actions to the digital inputs and the digital outputs. The I/O connector is on upper middle right side of the rear panel.

7.1.1 Digital I/O Specifications

Connector type on Instrument – Phoenix Contact #1827596

Mating Connector – Phoenix Contact #1827761

Digital Input Ratings:

Opto-isolated input – Vishay TCMT4600.

Isolation 3750 VACRMS.

LED type input with 2k ohm resistance in series.

Absolute maximum forward current 50 mA.

LED forward voltage 1.25 V @ 50 mA typical, 1.6 V max.

Can be direct driven with a 5 volt DC source.

Digital Output Ratings:

Open drain Mosfet with 0.75 ohm resistance from source to ground.

Mosfet type – Vishay SI2318CDS-T1-GE3.

Absolute maximum Voltage 40 VDC.

Drain-source on resistance 0.051 ohm max.

Drain-source maximum current 1 A. (Intentionally reduced this value)

Connector Pin Out designation corresponds to numbers on the connector:

- 1 – Ground
- 2 – Input #1
- 3 – Input #2
- 4 – Input #3
- 5 – Ground
- 6 – Output #1
- 7 – Output #2
- 8 – Output #3

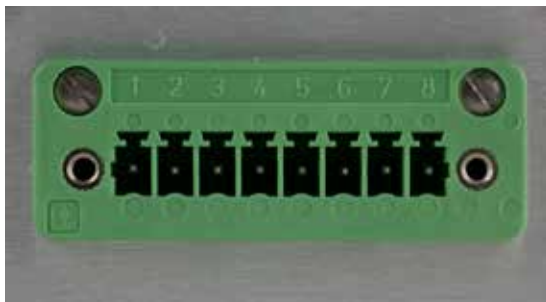

EN

7. Remote Operation

7.2 Remote Operating Parameters

Use the screens in Section 6.4.5 Remote Application to set the remote operating parameters for the instrument command set, Ethernet, Serial (RS-232) and IEEE-488 (GPIB) communications.

EN

7.3 Command Set

Command Set button – Users' can select which model remote protocol they would like to emulate for simulation and testing purposes. Selections may include the following or may be added per customers' specifications:

- Mensor (default)
- SCPI WIKA (The SCPI WIKA mode emulates the WIKA command set in SCPI format.)

7.4 IEEE-488

IEEE-488 address button – Allows the user to set the GPIB address by inputting a numeric value utilizing the touch screen.

7.4.1 IEEE-488.2 Commands

Command	Response/ Function
*IDN?	Returns identification string

7.5 Ethernet

The Ethernet function allows the user to set the following by inputting a numeric value in each separate field:

- IP
- Netmask
- Gateway
- Port
- DHCP settings

Set the Ethernet communication parameters as described in Section 6.4.5.



CAUTION! Please contact your network administrator for proper settings.



CAUTION! Please consult your computer resources department prior to connecting this instrument to your network to verify there are no conflicts with existing IP addresses.

The Ethernet communication port allows the CPC7000 to communicate with computers using 10/100Based-T specifications. Before using Ethernet communication, four parameters must be set up: IP, Netmask, Gateway, and Port.

7. Remote Operation

7.6 Serial

Set the Serial communication parameters as shown in Section 6.4.5 Remote Application. The serial communication port allows the CPC7000 to communicate in RS-232 format with computers, terminals, PDAs, or similar hosts.

These parameters should be set to match your host computer. Default settings are: 9600 baud, 8 data bits, 1 stop bit, no parity, and no echo.

If echo is ON, the CPC7000 will immediately echo back characters sent over the serial port. The Serial function allows the user to set the RS-232 serial port settings by selecting from the choices provided:

- Baud
 - ⇒ 9600
 - ⇒ 19200
 - ⇒ 38400
 - ⇒ 57600
 - ⇒ 115200
- Data Bits
 - ⇒ 7
 - ⇒ 8
- Stop Bits
 - ⇒ 1
 - ⇒ 2
- Parity
 - ⇒ Even
 - ⇒ Odd
 - ⇒ None
- Echo settings
 - ⇒ On
 - ⇒ Off

7.6.1 Serial Cable Requirements

RS-232 communications are transmitted over a three conductor, shielded cable terminated in a standard DB9 connector on the instrument end, and a different gender connector on the host end. The proper pin-outs are shown in the following illustration.



7. Remote Operation

7.7 Mensor Command Set

This Mensor command set is the default on the CPC7000. For queries (ending with a ?), the Data column represents the response of the CPC7000. All response strings begin with a space character or an "E" representing that there is an error in the error queue. All response strings are terminated with a <CR> and a <LF>. The error queue holds the last 10 errors identified.

EN

For all commands (no ?), the data column represents the required parameters to be sent to the CPC7000 following the string in the command column. For any command that requires multiple parameters to be sent, the parameters must be separated by commas.

7.8 Command and Query Format

Commands must be sent in ASCII format and terminated with either a carriage return (<cr>), linefeed (<lf>), or both. Commands are not case sensitive. Each query returns a response. If an error is detected the response will include an error flag.

Command or Query field: Unless otherwise specified, commands are typically converted to queries by appending a question mark to the command. Table 6.11 lists all of the CPC7000 command or query keywords.

Data field: The data field is either in ASCII {string} or numeric {value} form. In the case of multiple data fields, commas are required to separate the fields. Queries do not have a data field. String (text) or value (numeric) data are acceptable in any of the following formats:

Examples of {string} data: ON, OFF, mBar, inHg

Examples of {value} data: 1, 1.0, -5.678, 25.68324e-5

7.9 Command Set Definitions

In this manual a data entry made up of alpha characters is defined as a string, as opposed to data containing only numbers, such as "Enter 1 for ON or 0 for OFF" where 1 and 0 are defined as values.

Command: Any command or query listed in Table 6.11. For commands that take boolean data the following strings are acceptable:

0 1
False True
No Yes
Off On

Separator: Space (SP).

Data: ASCII representations of numbers, {value}, or alpha characters, {string}, data as defined above. When sending code a literal variable replaces the brackets and the enclosed character(s) shown in the following examples.

Termination: Linefeed (LF) or carriage return (CR) is used to signal the end of a command statement. For IEEE-488.2 operation "EOI" is an acceptable alternative.

Always send commands in one of the following formats:

1. [Command] [Termination];
2. [Command] [Separator] [Data] [Termination];
3. Queries are special instructions in the form: [Command?] [Termination] where the question mark, "?", immediately precedes the terminator.

When a valid query is received, the CPC7000 will return {data} terminated by CR and LF. Floating point data is returned in the current engineering units in exponential format.

7.10 Output Formats

Pressure readings are returned in exponential notation in a format according to the OUTFORM command as follows.

Output formats

1. <sp> pressure value <cr><lf>
2. <sp> pressure, units, mode <cr><lf>
3. <sp> pressure, pressure rate <cr><lf>
4. <sp> pressure, minimum peak, maximum peak<cr><lf>
5. <sp> pressure, active sensor (P or S) active turndown (1-2)<cr><lf>
6. <sp> pressure, control point, "stable" or "slewing"<cr><lf>
7. <sp> pressure, "no barometer" or baro reading<cr><lf>

0019104001D 10/2018EN

7. Remote Operation

7.11 CPC7000 Commands and Queries

Table 8.11 lists all of the current CPC7000 commands and queries.

Optional emulation modes are available in which a CPC7000 can emulate remote functions of different brands of pressure gauges. Please contact Mensor for more details.

EN

Command	Data	Response/Function
?	See Section 8.10	Returns data per the current output format
Acquire?	15 char string. Ex: Acquire? Test_stand_1 Returns: <sp>(YES or NO), CCC...CCC<cr><lf>	This command is used when multiple computers would like to control the instrument. Yes if acquisition is successful. No if instrument is being controlled with another computer. CCC...= name of controlling computer (see Release? and Unlock)
Address	1-31	Sets the GPIB Address
Address?	<sp>nn<cr><lf>	Returns the GPIB Address
Asset_tag	16 char string	General purpose string for customer use
Asset_tag?	<sp>ssssssssssssss<cr><lf>	Return customer asset tag string
Autorange	ON or OFF	Sets whether the autorange function is enabled or disabled
Autorange?	<sp>(ON or OFF)<cr><lf>	Returns whether the autorange function is enabled or disabled.
Autozero	none	Re-zero all the ranges. These adjustments are not password protected and are saved through power cycles. This command takes approximately 60 seconds but may take longer depending on the time to become stable.
Autozero?	S,T,X,X	Returns autozero data where S represents state (0 = complete, 1 = local autozero, 2 = remote autozero), T represents the estimated time to complete in seconds, and x is a (0) character since this data location is not used at this time.
Autozeroabort	none	Aborts autozero. Any transducers that have been zeroed will not revert to previous zero offsets.
Auxdisp <n>	NONE,PEAK,RATE,RATE SETPOINT,UNCERTAINTY,UNITS,BAROMETER, SOURCE PRESSURE	Sets the auxiliary display setting for index <n> (0 to 2). If <n> is left out, defaults to index 0.
Auxdisp? <n>	<sp>NONE,PEAK,RATE,RATE SETPOINT,UNCERTAINTY,UNITS, BAROMETER, SOURCE PRESSURE <cr><lf>	Returns the auxiliary display setting for index <n>. If <n> is left out, defaults to index 0.
Baro?	<sp>+n.nnnnnE+nn<cr><lf>	Returns reading from barometric transducer or "NO BAROMETER" if one isn't installed
Burst_Start		Changes the screen to the Burst Test if on another screen, begins the burst test with current parameters.
Burst_Stop		Stops the test and vents the system.
Burst_State?	<sp>(IDLE or RUNNING or COMPLETE)<cr><lf>	Returns state of the burst test
Burst_Low	Value inside upper and lower limits	This is the lower pressure of the anticipated "burst range"
Burst_Low?	<sp>n.nnnnnE+nn<cr><lf>	Returns the lower pressure limit for burst test
Burst_High	Value inside upper and lower limits	This is the higher pressure limit of the anticipated "burst range"
Burst_High?	<sp>n.nnnnnE+nn<cr><lf>	Returns the higher pressure limit for burst test

0019104001D 10/2018 EN

7. Remote Operation

EN

Burst_Slow	Value inside upper and lower limits	This is the rate used during the transition from low setpt to high setpt in the anticipated "burst range"
Burst_Slow?	<sp>n.nnnnnE+nn<cr><lf>	Returns the slow rate for burst test
Burst_Fast	Value inside upper and lower limits	This is the rate used during the transition from atmosphere to the low setpt
Burst_Fast?	<sp>n.nnnnnE+nn<cr><lf>	Returns the fast rate for burst test
Burst_Result?	<sp>n.nnnnnE+nn<cr><lf>	Pressure at which burst was detected. Will return 0 if no burst found.
Calculate_as_found_linearity		Calculate linearity slopes and intercepts from true/actual pressures
Caldisable	YES,NO	Sets whether or not calibration of the active transducer is disabled.
Caldisable?	<sp>(YES or NO)<cr><lf>	Returns whether or not calibration of the active transducer is disabled.
Cerr	None	Clears the error queue
Cmdset	Mensor, SCPI	Activates remote command set for instrument emulation modes.
Cmdset?	<sp><CCCCC><cr><lf>	Returns active command set identifier
Control		Instrument placed in Control Mode
Control?	<sp>(YES or NO)<cr><lf>	Returns YES if instrument is in control. NO if otherwise
Crate	Slow, Medium, Fast, Variable	Sets the control rate, Variable mode is a predetermined user defined rate setpt.
Crate?	<sp>CCCCC<cr><lf>	Returns the control rate – CCCC is variable in length and corresponds to the parameters for the CRATE command
Ctype?		Returns the type of regulator
Decpt?	<sp>n<cr><lf>	Returns the number of decimal points (see Resolution)
Default	None	Sets the default values
DHCP	ON or OFF	Reserved for DHCP setup
DHCP?	<sp>(YES or NO)<cr><lf>	Reserved for DHCP setup
DIO	2 or 0	2 turns on the first digital output pin, 0 turns it off
DIO?	<sp>n<cr><lf>	Returns status of the first input and output pin. Bit0 = input's status, Bit1 = output's status.
DOUTFUNC	<n><sp><CCCCC><cr><lf>	Sets the function for output pin <n> to NONE, STABLE, MEASURE, CONTROL, VENT
DOUTFUNC? <n>	<sp><CCCCC><cr><lf>	Returns the function for output pin <n>
DINFUNC	<n><sp><CCCCC>	Sets the function for input pin <n> to NONE, MEASURE, CONTROL, VENT, KEYLOCK, START, READING
DINFUNC? <n>	<sp><CCCCC><cr><lf>	Returns the function for output pin <n>
DOUTSTATE	<n><sp><HIGH/LOW/1/0>	Turns output pin <n> to high, or low. Sets the function for that pin to "None"
DIOSTATE?	<sp><n><cr><lf>	Bit 0-5 is the status of the Input bits, Bit 6-11 are the status of the Output bits. Returns an integer between 0 and 4095
DOC	mm/dd/yyyy	Sets the date of cal for the active transducer.
DOC?	<sp>mm/dd/yyyy<cr><lf>	Returns the date of cal for the active transducer.
DOM?	<sp>mm/dd/yyyy<cr><lf>	Returns the date of manufacture
Error?	<sp> text description <cr><lf>	Returns the next error in the error queue

0019104001D 10/2018EN

7. Remote Operation

Errorno?	<sp>Enn-text<cr><lf>	Returns pcs400 error code and text
Filter	OFF, LOW, NORMAL, HIGH	Sets the reading filter 0, 80%, 92%, 95%
Filter?	<sp> (filter)<cr><lf>	Returns the reading filter.
Gasdensity	Value in lb/cuft, or "NITROGEN" or "DRYAIR"	Sets the head pressure gas density in lb/cuft
Gasdensity?	<sp>+n.nnnnnE+nn<cr><lf>	Gets the head pressure gas density in lb/cuft
Gastemp	Value in degrees F	Sets the head pressure gas temperature
Gastemp?	<sp>+n.nnnnnE+nn<cr><lf>	Gets the head pressure gas temperature
Gateway	nnn.nnn.nnn.nnn	Sets the Ethernet gateway address
Gateway?	<sp>nnn.nnn.nnn.nnn<cr><lf>	Gets the Ethernet gateway address
Height	Value in inches	Sets the head pressure height in inches
Height?	<sp>+n.nnnnnE+nn<cr><lf>	Gets the head pressure height in inches
Id?	<sp>MENSOR,CPC7000, ssssss,v.v.vv<cr><lf>	Ssssss is the serial number,v.v.vv is the CPC7000 software version.
IP	nnn.nnn.nnn.nnn	Sets the IP address of the instrument
IP?	<sp>nnn.nnn.nnn.nnn<cr><lf>	Returns the IP address of the instrument
Keylock	YES or NO	Locks or unlocks the entire touch screen
Keylock?	<sp>(YES or NO)<cr><lf>	Returns Yes or No
Leak_Start		Changes the screen to the Leak Test if on another screen, begins the leak test with current parameters.
Leak_Stop		Stops the test and vents the system.
Leak_State?	<sp>(IDLE or RUNNING or COMPLETE)<cr><lf>	Returns state of the leak test
Leak_Setpt	Value inside upper and lower limits	Starting point for the leak test to begin at
Leak_Setpt?	<sp>n.nnnnnE+nn<cr><lf>	Returns starting setpt
Leak_Dwell	0 to 3600	The duration of the test during which a leak is measured
Leak_Dwell?	<sp>n.nnnnnE+nn<cr><lf>	Returns the dwell time in seconds
Leak_Pre_Dwell	0 to 3600	Pre-dwell parameter is the time in between going to measure mode, and the dwell time. Useful if there are pressure transients after switching the measure.
Leak_Pre_Dwell?	<sp>n.nnnnnE+nn<cr><lf>	Returns the pre-dwell time.
Leak_Delta_Limit	Value within the range of the sensor	Threshold for a passing/failing leak test.
Leak_Delta_Limit?	<sp>n.nnnnnE+nn<cr><lf>	Returns the maximum pressure change allowed before failure
Leak_Pass?	<sp>(YES or NO)<cr><lf>	
Leak_Delta?	<sp>n.nnnnnE+nn<cr><lf>	Returns the change in pressure since start of test.
List?	<sp>Pri,1,2;Sec,1,2;Ter,1,2;Bar,1<cr><lf>	Returns list of available transducers and turn downs for the instrument
Listcal?	<sp>PRI,{sn},1,{mmdyyy},2,{mddy yyyy};SEC,{sn},1,{mmdyyy},2,{mddy yyyy};TER,{sn},1,{mmdyyy},2,{mddy yyyy}<cr><lf>	Returns the serial number of each installed transducer and calibration dates for each range
Listrange?	<sp>PRI,1,min,max,2,min,max;SEC,1, min,max- ,2,min,max; TER,1,min,max,2,min,max <cr><lf>	Returns the ranges of the installed transducers.
Listsensorinfo?	<sp>PRI,SN,PTYPE,ACCURACY,1,min,max,2,min,- max;SEC,SN,PTYPE,ACCURACY,1,min,max,2,min,- max; TER,SN,PTYPE,ACCURACY,1,min,max- ,2,min,max	Returns the serial number, pressure type, accuracy, and ranges of the installed transducers
Localgravity	Value in ft/s^2	Sets the local gravity in feet/sec^2

EN

0019104001D 10/2018 EN

7. Remote Operation

EN

Localgravity?	<sp>+n.nnnnnE+nn<cr><lf>	Returns the local gravity in feet/sec^2
LowerLimit	Value inside primary xducer range in current units.	Sets the lower control limit for the instrument
LowerLimit?	<sp>n.nnnnnE+nn<cr><lf>	Returns the lower control limit for the instrument in current units.
Macaddress?	<sp>cc-cc-cc-cc-cc-cc<cr><lf>	Returns Ethernet MAC address
Measure	None	Instrument placed in Measure Mode
Measure?	<sp>(YES or NO)<cr><lf>	Returns YES if instrument is in measure. NO if otherwise
Mode	MEASURE, CONTROL, VENT, STANDBY	Sets the operation mode
Mode?	<sp>XXXXXX<cr><lf>	Returns the operation mode
Netmask	nnn.nnn.nnn.nnn	Sets the Ethernet network mask
Netmask?	<sp>nnn.nnn.nnn.nnn<cr><lf>	Gets the Ethernet network mask
Outform	1 to 7 – see table in Section 7.10	Sets the output format
Outform?	<sp>X<cr><lf>	Returns the output format – see table in Section 7.10
Peakmax?	<sp>n.nnnnnE+nn<cr><lf>	Returns the maximum pressure since peakreset was sent
Peakmin?	<sp>n.nnnnnE+nn<cr><lf>	Returns the minimum pressure since peakreset was sent
Peakreset	None	Resets the peak values.
Port	nnnnnn	Sets the Ethernet port of the instrument
Port?	<sp>nnnnn<cr><lf>	Returns the Ethernet port of the instrument
Ptype	Absolute or Gauge	Sets the instrument pressure type – emulation only works if the optional barometric transducer is installed. If no barometer is present, standard atmosphere is used for the barometric reading when in emulation mode.
Ptype?	<sp>CCCCC<cr><lf>	Returns “Absolute” or “Gauge” for the pressure type in native mode and “Absolute Emulated” or “Gauge Emulated” for the emulated pressure types
RangeMax?	<sp>n.nnnnnE+nn<cr><lf>	Returns the maximum range of the active transducer in the current units.
RangeMin?	<sp>n.nnnnnE+nn<cr><lf>	Returns the minimum range of the active transducer in the current units.
Rate?	<sp>n.nnnnnE+nn<cr><lf>	Returns the rate reading of the instrument in current units/current time unit (see Runits)
Rdecpt?	<sp>n<cr><lf>	Returns the number of rate decimal points. (see Resolution)
Release?	15 char string. EX: Release? Test_stand_1 Returns: <sp>(YES or NO), CCC...CCC<cr><lf>	This command is used to release control of the instrument in a multiple computer environment. Yes if release is successful No if instrument is being controlled with another computer CCC... = name of controlling computer or AVAILABLE (see Acquire? and Unlock)
Resolution	<n>	Sets the number of significant digits. (see decpt)
Resolution?	<sp>n<cr><lf>	Returns the number of significant digits. (see decpt)
Rfilter	Value in %	Sets the % of the rate filter
Rfilter?	<sp>n.nnnnnE+nn<cr><lf>	Returns the rate filter.
Rsetpt	Value in current units	Sets the rate setpoint
Rsetpt?	<sp>n.nnnnnE+nn<cr><lf>	Returns the rate setpoint

0019104001D 10/2018EN

7. Remote Operation

Runits	Sec, min, hr	Sets the rate time unit
Runits?	<sp>XXXX<cr><lf>	Returns the rate time unit
Save_cal		Save calibration values
Save_linearity		Save linearity values
Sbaud	9600, 19200, 38400, 57600, 115200	Sets the serial baud rate
Sbaud?	<sp>XXXX<cr><lf>	Returns the serial baud data
Sdata	7 or 8	Sets the serial data bits
Sdata?	<sp>n<cr><lf>	Returns the serial data bits number
Sensor	<s><td> ex. 11, 12, 21, 22, 31, 32	Sets the active transducer, <s>, where the first number is which transducer (1 to 3), and the second number is the turndown, <td>, (1 or 2)
Sensor?	<sp><s><td><cr><lf>	Returns active transducer in long string format
Sensorid?	<sp>Mensor,SN XXXXXX, VN.NN	Returns the active transducer's serial number and firmware version
Setpt	Value inside upper and lower limits	Sets the control setpoint for the instrument
Setpt?	<sp>XXXXXXXX<cr><lf>	Returns the control setpoint in current units.
Setpt%	Value in % of current range	Sets the control setpoint in % of current range
Setptpct	Value in % of current range	Sets the control setpoint in % of current range
Setptpct?	<sp>n.nnnnnE+nn<cr><lf>	Returns the current setpoint in % of current range
Span	Desired pressure or ?	Sets span on active transducer or for ?, clears previous value, must be > 50% FS and has a 1% limit. CALDISABLE must be OFF/NO.
Span?	<sp>XXXXXXXX<cr><lf>	Returns span scale factor for active transducer
Sparity	Even, ODD, NONE	Sets the serial parity
Sparity?	<sp>CCCC<cr><lf>	Returns the serial parity
Srqmask	Stable,Error or both	Sets the CPC7000 to issue a service request(SRQ) over the IEEE when the pressure control is stable, or an error occurs. These are 80 hex and 40 hex respectively.
Srqmask?	<sp>{string}<cr><lf>	Returns "stable", "error" or "error, stable" depending on the SRQ.
Sstop	1 or 2	Sets the serial stop bits
Sstop?	<sp>X<cr><lf>	Returns the serial stop bits
Stable?		Returns YES if instrument is stable or No
Stabledelay	0 to 3600	Sets the stable time to the number of seconds specified
Stabledelay?	<sp>XXXXXXXX<cr><lf>	Returns the stable time.
Stabletime	0 to 3600	Sets the stable time to the number of seconds specified
Stabletime?	<sp>XXXXXXXX<cr><lf>	Returns the stable time.
StableWin	%FS value	Sets the stable window as a %FS
StableWin?	<sp>n.nnnnnE+nn<cr><lf>	Returns the stable window.
Standby	None	Instrument placed in Standby Mode
Standby?	<sp>(YES or NO)<cr><lf>	Returns yes if instrument is in Standby, no if otherwise
Step	Value inside upper/lower limits and inside the range of the active transducer.	Sets the control step size for the instrument
Step-		Jogs the setpoint down one step
Step+		Jogs the setpoint up one step

EN

0019104001D 10/2018 EN

7. Remote Operation

EN

Step?	<sp>+n.nnnnnE+nn<cr><lf>	Returns the control step for the instrument
Step%	Value in % of current range	Sets the control step in % of current range
Steppct	Value in % of current range	Sets the control step in % of current range
Steppct?	<sp>n.nnnnnE+nn<cr><lf>	Returns the current step in % of current range
Switch_Start		Changes the screen to the Switch Test if on another screen, begins the switch test with current parameters.
Switch_Stop		Stops the test and vents the system.
Switch_State?	<sp>(IDLE or RUNNING or COMPLETE)<cr><lf>	Returns state of the switch test
Switch_Low	Value inside upper and lower limits	Starting setpt for the switch test to begin at
Switch_Low?	<sp>+n.nnnnnE+nn<cr><lf>	Returns starting setpt
Switch_High	Value inside upper and lower limits	Finishing setpt for the switch test to end at
Switch_High?	<sp>+n.nnnnnE+nn<cr><lf>	Returns ending setpt
Switch_Fast	Value inside upper and lower limits	Rate at which switch test will go to the low setpt
Switch_Fast?	<sp>+n.nnnnnE+nn<cr><lf>	Returns fast rate setpt
Switch_Slow	Value inside upper and lower limits	Rate at which switch test will go to the high setpt
Switch_Slow?	<sp>+n.nnnnnE+nn<cr><lf>	Returns slow rate setpt
Switch_1_Up?	<sp>+n.nnnnnE+nn<cr><lf>	Returns the pressure at which switch 1 tripped while going up scale. Returns 0 if switch was not triggered.
Switch_1_Dn?	<sp>+n.nnnnnE+nn<cr><lf>	Returns the pressure at which switch 1 tripped while going down scale. Returns 0 if switch was not triggered.
Switch_2_Up?	<sp>+n.nnnnnE+nn<cr><lf>	Returns the pressure at which switch 2 tripped while going up scale. Returns 0 if switch was not triggered.
Switch_2_Dn?	<sp>+n.nnnnnE+nn<cr><lf>	Returns the pressure at which switch 2 tripped while going down scale. Returns 0 if switch was not triggered.
Switch_3_Up?	<sp>+n.nnnnnE+nn<cr><lf>	Returns the pressure at which switch 3 tripped while going up scale. Returns 0 if switch was not triggered.
Switch_3_Dn?	<sp>+n.nnnnnE+nn<cr><lf>	Returns the pressure at which switch 3 tripped while going down scale.
Tare	ON / OFF	Tares the reading to zero
Tare?	<sp> n.nnnnnE+nn <cr><lf>	Returns value of Tare
Termchar	CCCC	Set the ouptput termination character(s). CR, LF, CRLF, DEFAULT, EOI, NONE
Termchar?		Returns the termination character setting
Transfer_factory_to_linearity		Copy factory linearity coefficients to customer
Units	Units code or text in table below	Sets the instrument engineering units
Units?	<sp>CCCC<cr><lf>	Returns the instrument units in a text string
Unitbase1	Units code or text in table below	Sets the user 1 base engineering units
Unitbase1?	<sp>CCCC<cr><lf>	Returns the user 1 base units in a text string
Unitbase2	Units code or text in table below	Sets the user 2 base engineering units
Unitbase2?	<sp>CCCC<cr><lf>	Returns the user 2 base units in a text string
Unitfact1	Multiplier factor	Sets the user 1 unit mulitplier
Unitfact1?	<sp>n.nnnnnE+nn<cr><lf>	Returns the user 1 unit multiplier
Unitfact2	Multiplier factor	Sets the user 2 unit mulitplier
Unitfact2?	<sp>n.nnnnnE+nn<cr><lf>	Returns the user 2 unit multiplier

0019104001D 10/2018EN

7. Remote Operation

Unlock	None	Releases Acquire locks (see Acquire? and Release?)
UpperLimit	Value inside primary transducer range in current units.	Sets the Upper control limit for the active transducer.
UpperLimit?	<sp>xxxxxx<cr><lf>	Returns the upper control limit for the active transducer.
Vent	None	Instrument placed in Vent Mode
Vent?	<sp>(YES or NO)<cr><lf>	Returns yes if instrument is in Vent, no if otherwise
Vent_Rate	Value in current units	Sets the Vent Rate of the instrument
Vent_Rate?	<sp>n.nnnnnE+nn<cr><lf>	Returns the Vent Rate of the instrument
Vent_Limit	Value in current units	Sets the Vent Limit
Vent_Limit?	<sp>n.nnnnnE+nn<cr><lf>	Returns the Vent Limit
Volume	value in cc	Sets the system volume in cc's
Volume?	<sp>xxx<cr><lf>	Returns the system volume in cc's
Window	Value in current units	Sets the exponential filter window for the active transducer
Window?	<sp>n.nnnnnE+nn<cr><lf>	Returns the exponential filter window for the active transducer
Zero	Desired pressure or ?	Sets zero to set pressure or for ?, clears previous value. CALDISABLE must be OFF/NO.
Zero?	<sp>n.nnnnnE+nn<cr><lf>	Returns zero offset for active transducer

EN

7. Remote Operation

7.11.1 Units Command Syntax for Measurement Units

n	Description	Output Format	Type
1	pounds per square inch	PSI	Imperial
2	inches of mercury @ 0°C	INHG	Imperial
3	inches of mercury @ 60°F	INHG	Imperial
4	inches of water @ 4°C	INH2O	Imperial
5	inches of water @ 20°C	INH2O	Imperial
6	inches of water @ 60°F	INH2O	Imperial
7	feet of water @ 4°C	FTH2O	Imperial
8	feet of water @ 20°C	FTH2O	Imperial
9	feet of water @ 60°F	FTH2O	Imperial
10	millitorr	MTORR	Metric
11	inches of sea water @ 0°C	INSW	Imperial
12	feet of sea water @ 0°C	FTSW	Imperial
13	atmospheres	ATM	Imperial
14	bars	BAR	Metric
15	millibars	MBAR	Metric
16	millimeters of water @ 4°C	MMH2O	Metric
17	centimeters of water @ 4°C	CMH2O	Metric
18	meters of water @ 4°C	MH2O	Metric
19	millimeters of mercury @ 0°C	MMHG	Metric
20	centimeters of mercury @ 0°C	CMHG	Metric
21	torr	TORR	Metric
22	kilopascals	KPA	Metric
23	pascals	PA	Metric
24	dynes per square centimeter	DY/CM ²	Metric
25	grams per square centimeter	G/CM ²	Metric
26	kilograms per square centimeter	KG/CM ²	Metric
27	meters of sea water @ 0°C	MSW	Metric
28	ounce per square inch	OSI	Imperial
29	pounds per square foot	PSF	Imperial
30	tons per square foot	TSF	Imperial
32	micron of mercury @ 0°C	mHG	Metric
33	tons per square inch	TSI	Imperial
34	meters of mercury @ 0°C	MHG	Metric
35	hectapascals	HPA	Metric
36	megapascals	MPA	Metric
37	millimeters of water @ 20°C	MMH2O	Metric
38	centimeters of water @ 20°C	CMH2O	Metric
39	meters of water @ 20°C	MH2O	Metric

EN

0019104001D 10/2018EN

7. Remote Operation

7.11.2 CPC7000 Error Codes

Code	Serial Poll Byte	Description	Error String Returned
E00	00h	No errors	NO ERRORS
E05	45h	Parameter error	EGPIB PARAMETER ERROR: String that was sent
E07	47h	Syntax error	EGPIB SYNTAX ERROR: String that was sent

EN

7.11.3 SCPI Commands and Queries

The WIKA SCPI command is compatible with older WIKA instruments such as the original CPC8000

Notes:

- Note that WIKA and Ruska 7010 Emulation return slightly different responses to some queries.
- Except for the engineering units selection, the numeric suffix selects the applicable transducer [R]:
 - 1= Sensor 1 (default Turndown 1)
 - 11 = Sensor 1, Turndown 1
 - 12 = Sensor 1, Turndown 2
 - 2= Sensor 2 (default Turndown 1)
 - 21 = Sensor 2, Turndown 1
 - 22 = Sensor 2, Turndown 2

This numeric suffix [R] always defaults to the active transducer if not specified.

Command	Response/Function
STATus	
:OPERation	
:CONDition?	Returns an integer value representing instrument status that can be decoded. Bit 0: Zeroing active Bit 1: Control Setpoint has not been reached. Bit 2: Reserved 0. Bit 3: Reserved 0. Bit 5: Measuring. The instrument is actively measuring
MEASure	
[:PRESsure][R]?	Returns the pressure from range R
:TEMPerature[R]?	Returns the temperature from range R
:RATE[R]?	Returns the rate/sec from range R
:BAROmetric?	Returns the barometric pressure
CALibration	
[:PRESsure][R]	
:MODE?	Returns 1=calibrated or 0=not calibrated
:DATE?	Returns date of cal "MM/DD/YY"
:DATE <i,j,i>	Sets date of cal YYYY,MM,DD
:ZERO?	Returns zero offset
:ZERO <n>	Sets the zero offset
:ZERO:RUN	Start Autozero sequence
:ZERO:STOP	Stop Autozero sequence
:ZERO:INITiate?	Returns zero status
:ZERO:INITiate	Ignored
SENSe	
[:PRESsure][R]	

0019104001D 10/2018 EN

7. Remote Operation

EN

:NAME?	Returns transducer name string
:MODE?	Returns "ABSOLUTE" or "GAUGE"
:MODE ABS GAUGE	Sets pressure type
:ABS?	Returns native transducer type 0=GAUGE 1=ABSOLUTE
:RESolution?	Returns resolution (float)
:RANGe	
[:UPPer]?	Returns maximum range
:LOWer?	Returns minimum range
:UNIT	
[:NAME]?	Returns ASCII units (mixed case)
:VALue?	Returns the units conversion factor
:REFerence	
[:HEIGht] <n>	Sets the head pressure height
:HEIGht?	Returns the head pressure height
:MODE?	Returns "OFF", "GAS", or "LIQUID"
:MODE OFF GAS LIQUID	Sets the head pressure mode
:MEDIum<n>	Sets the medium density
:MEDIum?	Returns medium
:ACTive <n>	Sets the active transducer
:ACTive?	Returns the active transducer
SYSTEM	
:DATE <i,i,i>	Not used, kept for backwards compatibility
:DATE?	Not used, does not cause an error, does not return a response
:TIME <i,i,i>	Not used, kept for backwards compatibility
:TIME?	Not used, does not cause an error, dose not return a response
:ERRor[:NEXT]?	Returns error code, description
:KLOCK ON OFF 1 0	Sets the keylock state
:PRESet	Load known state values
:SAVe	No function (not needed)
:VERSion?	Returns SCPI version 1994.0
TEST	
:ELECtronic?	Returns "OK"
:RELay<n>?	Returns status of digital output <n>
:RELay<n> ON OFF	Turns the digital output on or off <n>
UNIT	
:[PRESsure] bar mbar Pa psi	Sets the pressure units
:[PRESsure]?	Returns the pressure units

0019104001D 10/2018EN

7. Remote Operation

:NAME<n>?	Returns the units string for units code <n>																																																																																												
:FACTor <n>?	Returns the units conversion for units code <n>																																																																																												
:INDEX <n>	Sets the index number.																																																																																												
:INDEX?	Returns the index number. <table border="1"> <thead> <tr> <th>index</th> <th>unit</th> <th>index</th> <th>unit</th> </tr> </thead> <tbody> <tr><td>0</td><td>bar</td><td>21</td><td>OSI</td></tr> <tr><td>1</td><td>mbar</td><td>22</td><td>TSI</td></tr> <tr><td>2</td><td>Pa</td><td>23</td><td>TSF</td></tr> <tr><td>3</td><td>psi</td><td>24</td><td>ftH2O(20°C)</td></tr> <tr><td>4</td><td>atm</td><td>25</td><td>ftH2O(60°F)</td></tr> <tr><td>5</td><td>kp/cm2</td><td>26</td><td>inSW</td></tr> <tr><td>6</td><td>lbf/ft2</td><td>27</td><td>ftSW</td></tr> <tr><td>7</td><td>kPa</td><td>28</td><td>hPa</td></tr> <tr><td>8</td><td>cmH2O(4°C)</td><td>29</td><td>Mpa</td></tr> <tr><td>9</td><td>inH2O(4°C)</td><td>30</td><td>dyn/cm2</td></tr> <tr><td>10</td><td>inH2O(60°F)</td><td>31</td><td>mHg 0°C</td></tr> <tr><td>11</td><td>ftH2O(4°C)</td><td>32</td><td>Torr</td></tr> <tr><td>12</td><td>µmHg(0°C)</td><td>33</td><td>mTorr</td></tr> <tr><td>13</td><td>mmHg(0°C)</td><td>34</td><td>uHg 0°C</td></tr> <tr><td>14</td><td>cmHg(4°C)</td><td>35</td><td>mmH2O 4°C</td></tr> <tr><td>15</td><td>inHg(0°C)</td><td>36</td><td>mH2O 4°C</td></tr> <tr><td>16</td><td>inHg(60°F)</td><td>37</td><td>mmH2O 20°C</td></tr> <tr><td>17</td><td>--</td><td>38</td><td>cmH2O 20°C</td></tr> <tr><td>18</td><td>user</td><td>39</td><td>mH2O 20°C</td></tr> <tr><td>19</td><td>user</td><td>40</td><td>mSW</td></tr> <tr><td>20</td><td>user</td><td>41</td><td>g/cm2</td></tr> <tr><td></td><td></td><td>42</td><td>Kg/m2</td></tr> </tbody> </table>	index	unit	index	unit	0	bar	21	OSI	1	mbar	22	TSI	2	Pa	23	TSF	3	psi	24	ftH2O(20°C)	4	atm	25	ftH2O(60°F)	5	kp/cm2	26	inSW	6	lbf/ft2	27	ftSW	7	kPa	28	hPa	8	cmH2O(4°C)	29	Mpa	9	inH2O(4°C)	30	dyn/cm2	10	inH2O(60°F)	31	mHg 0°C	11	ftH2O(4°C)	32	Torr	12	µmHg(0°C)	33	mTorr	13	mmHg(0°C)	34	uHg 0°C	14	cmHg(4°C)	35	mmH2O 4°C	15	inHg(0°C)	36	mH2O 4°C	16	inHg(60°F)	37	mmH2O 20°C	17	--	38	cmH2O 20°C	18	user	39	mH2O 20°C	19	user	40	mSW	20	user	41	g/cm2			42	Kg/m2
index	unit	index	unit																																																																																										
0	bar	21	OSI																																																																																										
1	mbar	22	TSI																																																																																										
2	Pa	23	TSF																																																																																										
3	psi	24	ftH2O(20°C)																																																																																										
4	atm	25	ftH2O(60°F)																																																																																										
5	kp/cm2	26	inSW																																																																																										
6	lbf/ft2	27	ftSW																																																																																										
7	kPa	28	hPa																																																																																										
8	cmH2O(4°C)	29	Mpa																																																																																										
9	inH2O(4°C)	30	dyn/cm2																																																																																										
10	inH2O(60°F)	31	mHg 0°C																																																																																										
11	ftH2O(4°C)	32	Torr																																																																																										
12	µmHg(0°C)	33	mTorr																																																																																										
13	mmHg(0°C)	34	uHg 0°C																																																																																										
14	cmHg(4°C)	35	mmH2O 4°C																																																																																										
15	inHg(0°C)	36	mH2O 4°C																																																																																										
16	inHg(60°F)	37	mmH2O 20°C																																																																																										
17	--	38	cmH2O 20°C																																																																																										
18	user	39	mH2O 20°C																																																																																										
19	user	40	mSW																																																																																										
20	user	41	g/cm2																																																																																										
		42	Kg/m2																																																																																										
OUTPut																																																																																													
:STATe ON OFF 1 0	ON or 1 = Control OFF or 0 = Measure																																																																																												
:STATe?	Returns 0 for measure 1 for control																																																																																												
:MODE MEASure CONTrol VENT	Sets the mode indicated																																																																																												
:MODE?	Returns the mode string																																																																																												
:STABle?	Returns 1 if stable 0 if not																																																																																												
:AUTOvent ON OFF 1 0	Autovent is always true on CPC7000																																																																																												
:AUTOvent?	Returns the state of the Vent mode																																																																																												
:AUTORange ON OFF 1 0	Turns autorange on or off																																																																																												
:AUTORange?	Returns "ON" or "OFF"																																																																																												
[SOURce]																																																																																													
:PRESsure																																																																																													

EN

7. Remote Operation

EN

[:LEVe]	
[:IMMediate]	
[:AMPLitude] <n>	Sets the setpoint
[:AMPLitude]?	Returns the setpoint
:SLEW <n>	Sets the rate setpoint
:SLEW?	Returns the rate setpoint
:TOLerance?	Returns the stable window
:TOLerance<n>	Sets the stable window
CALCulate	
:LIMit	
:LOWer<n>	Set the minimum control limit
:LOWer?	Set the minimum control limit
:UPPer<n>	Set the maximum control limit
:UPPer?	Set the maximum control limit
:SYSTem	
:DETECT SLOW FAST CANCEL	Not used, kept for backwards compatibility
:DETECT?	Returns "0"

7.11.4 SCPI Commands Error Messages and Error Codes

All remote commands sent to the CPC7000 are shown in the Trouble Shooting App, under the "Remote" button. If there is a syntax error, an error message will appear below the errant command. Local errors and remote command errors will appear under the "Error" button. Maximum of 100 errors are stored and can be retrieved.

0019104001D 10/2018EN

8. Faults

8. Faults

EN

Type	Problem	Correction Action
1	The system has been switched on and no measurement(s) have appeared and the entire area of the screen is white (or dark).	Switch the system off. Wait 5 seconds and switch the system on.
2	The screen is dark and the corrective action for #1 above has no effect	Check that the power cable is connected properly and have authorized technical staff check that the supply voltage is correct.
3	The screen is dark and the action taken to solve the problem of #2 above has no effect.	Unplug the unit from the power source (wall socket), then remove the power cord from the instrument. The power cord input socket includes two internal fuses (see Figure 8.1 Fuse location) . Check both fuses for continuity. If needed, replace fuse elements (Figure 8.2 Fuse replacement) and mount the fuse holder back in place while making sure it is inserted all the way in.
4	Malfunction during operation.	Switch the system off. Wait 5 seconds and switch the system on.
5	Unstable control.	Consult factory
6	The setpoint value is not reached.	Check whether the value of the supply pressure is the value required, and leak test the plumbing.



WARNING! When needed, use only fuses with T1.6A / 250 V specification.



Figure 8.1 Fuse location



Figure 8.2 Fuse replacement

If you need help or assistance, contact Mensor at

- Phone: 1-512-396-4200 or 1-800-984-4200 (USA only)
- Fax: 512-396-1820
- Website: www.mensor.com
- Email: sales@mensor.com
tech.support@mensor.com

0019104001D 10/2018 EN

9. Maintenance and Recalibration

EN



For contact details, please see chapter 1 “General information” or the back page of the operating instructions.

9.1 Maintenance

The CPC7000 was designed for maintenance-free operation. User maintenance is not recommended, beyond replacement of parts listed in Table 9.1.2. If you have questions not covered by this manual, call 1-800-984-4200 (USA only), or 1-512-396-4200 for assistance, or send an email to tech.support@mentor.com.

9.1.1 Beyond the Warranty

Take advantage of Mensor’s expert product care. Mensor provides complete maintenance and calibration services, available for a nominal fee. Our service staff is knowledgeable in the innermost details of all of our instruments. We maintain units that are in operation in many different industries and in a variety of applications, and by users with a wide range of requirements. Many of these instruments have been in service for over twenty years, and continue to produce excellent results. Returning your instrument to Mensor for service benefits you in several ways:

- Our extensive knowledge of the instrument assures you that it will receive expert care.
- In many cases we can economically upgrade an older instrument to the latest improvements.
- Servicing our own instruments which are used in “real world” applications keeps us informed as to the most frequent services required. We use this knowledge in our continuing effort to design better and more robust instruments.
- Repair or replacement of the CPC7000 chassis, module and measurement transducers will be available up to 7 years after the production life cycle of the product, pending external vendor parts or equivalent parts availability. The production life cycle is defined as the time from the product series launch to the announcement of discontinuation (typically 8 to 10 years).
- All repairs associated with the chassis or internal modules should be performed by Mensor due to the complexity of performing these repairs. Replacement of measurement transducers can be done at the customer’s site.

9.1.2 Transducer Removal

Follow the following instructions for transducer removal or replacement:



CAUTION! The instrument must be completely vented and the power to the instrument must be switched off before beginning the transducer removal or replacement.

- VENT THE SYSTEM by placing the controller in vent mode. Then turn off the power.
- Loosen the Philips screws that secure the door.
- If the installed transducers are Gauge, remove the reference pressure connection by loosening the 9/16 - 18 UNF fitting (Figure 9.12).
- Remove the stop plate by loosening the four Philips screws (Figure 9.1.2).
- Pull out the reference transducer along with the adaptor block and connection cable.
- Remove the connection cable (9-ping D-Sub connector) from the top of the reference transducer
- Replacing the reference transducer from the adaptor block
 - ⇒ CPR8050: remove four Philips screws from the adaptor block to pull out and replace the transducer.
 - ⇒ CPR8000: remove two Philips screws from the adaptor block to pull out and replace the transducer.
- Attach the connection cable at the top of the reference transducer and tighten the reference transducer to the adaptor block.
- Push the reference transducer along with the adaptor block and connection plate into position.
- Attach the stop plate by tightening the four Philips screws and reconnect the reference pressure line if the installed transducers are Gauge.
- Close the door of the CPC7000 and secure it with two Philips screws.

9. Maintenance and Recalibration



CAUTION! There must be a transducer installed in the “Primary Transducer” slot for the regulator module to function properly. If the system is operated with the primary slot empty the system will display an error.

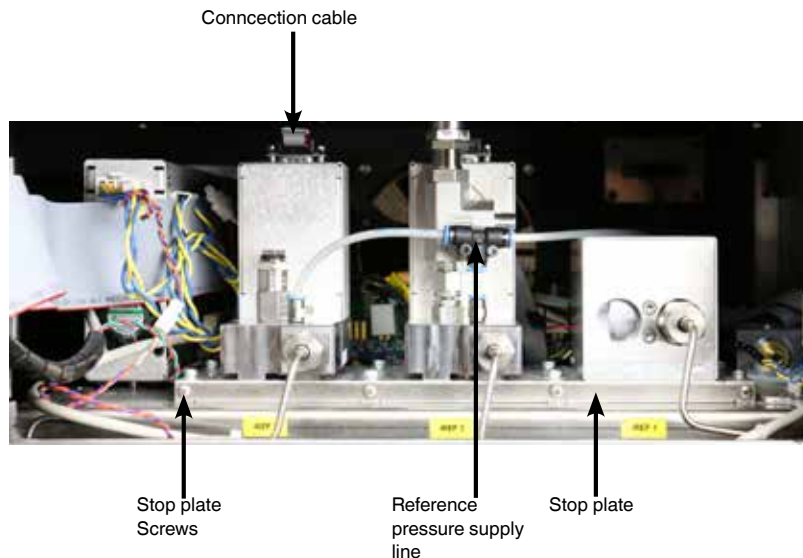

Figure 9.1.2 CPC7000 Front Panel

In replacing the transducer modules, the order of position must be maintained according to the pressure limit of each module, starting with the highest transducer on the left (Primary transducer) and the lower pressure transducer (Secondary transducer) on the right followed by the lowest pressure transducer (Tertiary transducer). If an optional Barometric Reference is present it is positioned in front of the first Primary transducer.



CAUTION! Further access to the interior of the instrument is **NOT** recommended. There are no user-serviceable plumbing or parts inside. In addition to the dangerous voltages present (line voltage), there are circuits sensitive to electrostatic discharge damage.



CAUTION

ESD PROTECTION REQUIRED. The proper use of grounded work surfaces and personal wrist straps are required when coming into contact with exposed circuits (printed circuit boards) to prevent static discharge to sensitive electronic components.



WARNING!

If faults cannot be corrected locally, immediately take the system off line and protect it from unintentional restarts. Contact Mensor Customer Service for further instructions. Apparent problems are frequently resolved over the telephone by our staff.

Do not risk voiding the warranty. Higher level repairs must be carried out exclusively by Mensor authorized personnel, or under Mensor supervision.

Servicing of electrical, electronic or pneumatic equipment must be performed by qualified and authorized technical staff, observing all relevant safety regulations.

9. Maintenance and Recalibration

9.1.3 Barometric Sensor (optional) Removal

To remove the optional Barometric reference sensor, first turn off the CPC7000 and loosen the Phillips head screws that secure the door. The barometric reference sensor is positioned behind the front door next to the primary transducer in the pressure controller (Figure 9.1.3). The barometric reference sensor can be removed by removing the attached ribbon cable, loosening the thumb screw, and lifting the barometric reference sensor out of the chassis.

EN

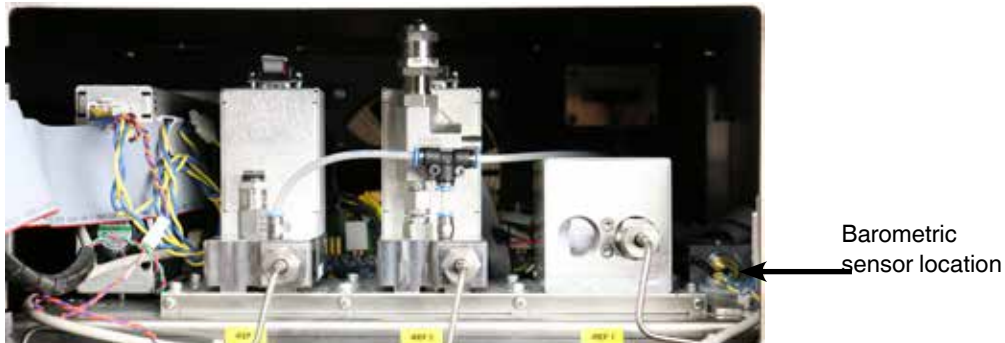

Figure 9.1.3 Internal Barometric Reference Sensor

9.1.4 Cleaning

Cleaning the CPC7000 outside housing has to be done only using a moistened cloth. The display/ touchscreen must be cleansed using only a soft microfiber cloth with the power to the unit turned off in order to avoid accidental touchscreen responses.



CAUTION! Further access to the interior of the instrument is **NOT** recommended. There are no user-cleanable components inside the chassis.

9. Maintenance and Recalibration

EN

9.2 Recalibration

The CPC7000 automatically adjusts the pressure reading for the effects of temperature and non-linearity within the calibrated temperature range of 15-45°C. The process is referred to as dynamic compensation because each reading is so adjusted before it is output to the display or to a communication bus. Thus, a calibrated CPC7000 operated within its temperature band, and with proper zero and span adjustments, will provide accurate pressure measurements.

The CPC7000 should have the calibration verified periodically to ensure stability. The recommended calibration interval for this instrument is given in the Specifications section under "Calibration Interval" in Section 11.1.

9.2.1 Calibration Services by Mensor or WIKA worldwide

Mensor and WIKA worldwide have extensive experience and knowledge of Mensor products. Calibration of the transducers in these products can be performed at the addresses below or by competent internal or external labs using the procedures in this section.

Service Center USA	Service Center Europe
Mensor website: www.mensor.com tel: 1-512-396-4200 1-800-984-4200 fax: 1-512-396-1820 email: tech.support@mensor.com	WIKA Alexander Wiegand SE & Co. KG website: www.wika.de / www.wika.com tel: (+49) 9372 132-5049 email: CTServiceTeam@wika.com
Service Center China	
WIKA China website: www.wika.cn contact: Baggio Li tel: (+86) 512 6878 8000 fax: (+86) 512 6809 2321 email: baggio.li@wika.com	

9.2.2 Environment

For maximum accuracy, allow the CPC7000 to warm up a minimum of 15 minutes in ambient temperature within the compensated range prior to a calibration. In addition, the instrument should be at rest on a stable platform that is free of excessive vibration and shock.

9.2.3 Pressure Standards

Mensor recommends the use of appropriately accurate primary pressure standards when calibrating this instrument. Such standards should be sufficient so that when the techniques of the ISO Guide to the Expression of Uncertainty in Measurement (GUM) are applied, the instrument meets its accuracy statements as required by ISO/IEC 17025:2005, or other applicable standards.

9.2.4 Media

The recommended calibration medium is dry nitrogen or clean dry instrument air. A height variation between the standard and the CPC7000 can cause errors. A calculation should be made to compensate for this difference. This compensation can be done in Section 9.10 Head Pressure.

9. Maintenance and Recalibration

9.2.5 Setup

The following illustration shows a typical setup for either local or remote calibration for an absolute or gauge pressure instrument. The PC is required only for performing a remote calibration.

EN

The "Pressure Standard" is normally a deadweight test instrument, and the "Volume Controller" refers to a hand operated variable-volume pressure vernier device. A diaphragm type vacuum gauge is recommended over the gauge tube type of vacuum sensor for calibrating sub-atmospheric pressures. A vacuum pump with the capacity to generate 600 mTorr absolute is recommended.

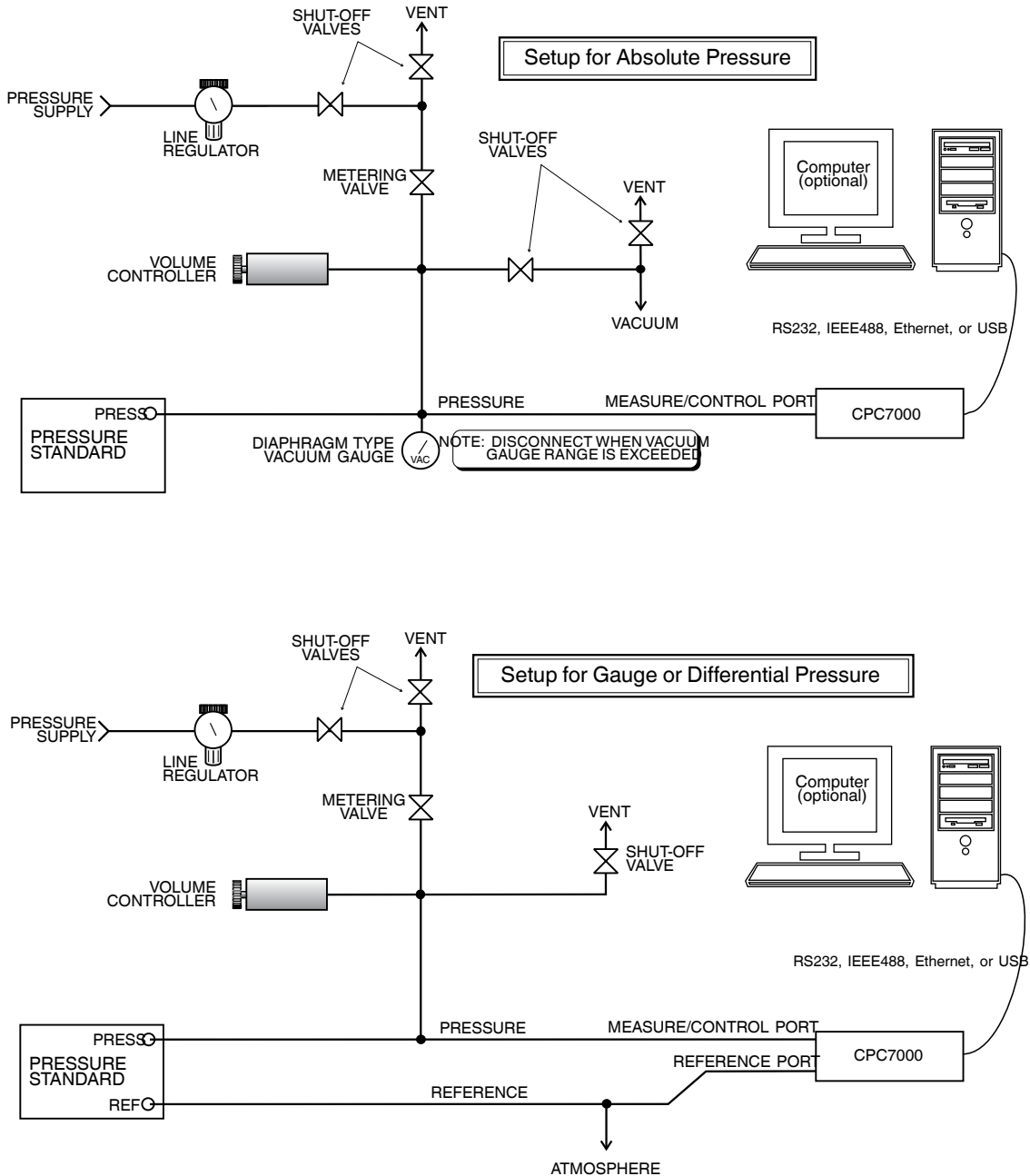



Figure 9.2.5 Calibration Setup

0019104001D 10/2018EN

9. Maintenance and Recalibration

9.2.6 Calibration Data

The Calibration Data Application is where the calibration data for each transducer is stored and amended. The serial number (S/N), Accuracy, zero offset (Zero) and span offset (Span) can be seen in this screen. The date of calibration, the calibration interval and the certificate number can be entered by pressing the corresponding button, then saved by pressing the Check [] button. To revert back to the factory calibration, press the “Restore Factory Cal” button. To view the calibration data for each transducer press the “Range” button at the top and choose a transducer from the resulting selection menu.

EN

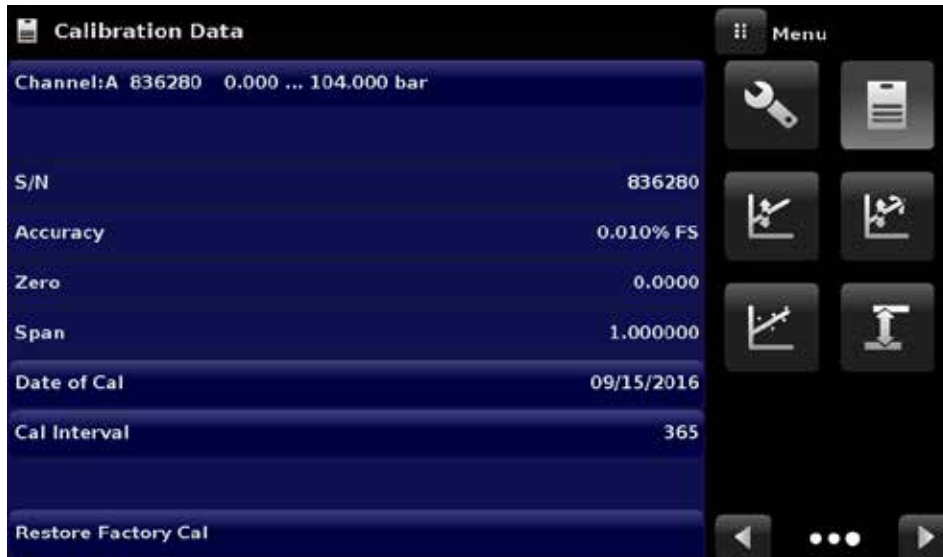
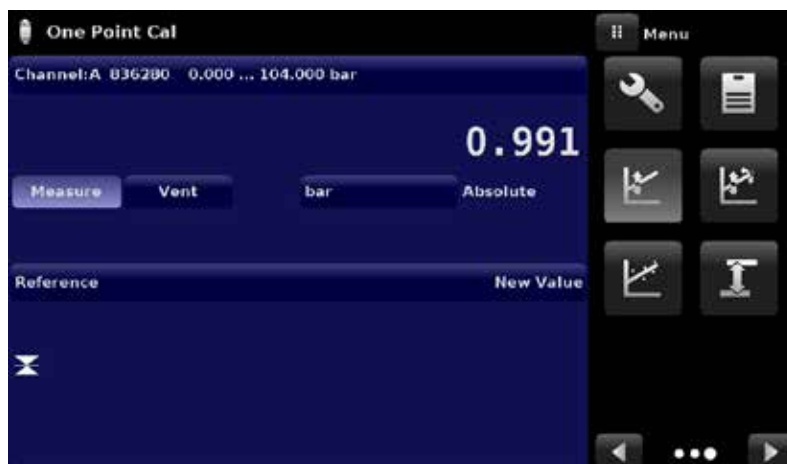

Figure 9.2.6 Calibration Data

9.2.7 One Point Cal Application

A single point calibration (usually a zero point calibration) of each transducer installed can be accomplished in “One Point Cal” Application. The transducer is chosen by pressing the “Range” button at the top of this screen, and then selecting from the list of installed transducers. For gauge pressure simply expose the reference and the Measure/Control port of the CPC7000 to atmospheric pressure and then press the “New Value” button and enter zero (0) using the keypad. For an absolute transducer, apply a known reference pressure between 600 mTorr absolute and 20% of the active transducer’s span to the Measure/Control port of the CPC7000, press the “New Value” button and then enter the reference pressure (known true pressure) using the keypad.

If you want to save the value in the transducer, press Save.



Notice the reference symbol [], this is the pressure reference level of the instrument.

Figure 9.2.7 One Point Calibration App

9. Maintenance and Recalibration

9.2.8 Two Point Cal Application



The Two Point Cal Application provides a place to adjust the Transducer Zero and Span (sometimes referred to as the offset and slope).

EN



Figure 9.2.8 Two Point Calibration App

Follow the steps below for a complete Two Point Calibration:

Select a Transducer to calibrate by pressing the Range button at the top of the screen.

To calibrate the “Low Point”:

1. The Measure/Control port of the CPC7000 being calibrated should be supplied with a suitable, “Low point” pressure (see section 5.4 - Rear Panel for the port location).
2. For a gauge transducer, this low point pressure can be achieved by opening the Measure/Control and reference ports to atmospheric pressure.
3. For an absolute transducer a suitable source of vacuum should be applied to the Measure/Control port along with a high accuracy vacuum standard or a pressure calibration standard can be connected to the Measure/Control port that can generate and measure a stable pressure value between 600 mTorr absolute and 20% of the active transducer’s span.
4. When the pressure is stable, record the live reading shown on the Two Point Cal screen and enter this value as the “Low Reading” by pressing the Low Reading button and entering the number followed by the check mark []. Record the “true pressure” obtained from the reference standard and enter it as the “Low Reference” value in the same manner.

To calibrate the “High Point”:

5. The “High Point” Calibration is done in a similar way as the “Low Point”.
6. Supply a pressure to the Measure/Control Port of the CPC7000 being calibrated, using a pressure standard. This pressure should be as close as possible to the full scale value of the selected transducer or at least within 20% of the active transducer’s span.
7. After the pressure stabilizes, record the live reading shown on the Two Point Cal screen and enter this value as the “High Reading” by pressing the High Reading button and entering the number followed by the check mark []. Record the “true pressure” obtained from the reference standard and enter it as the “High Reference” value in the same manner.
8. After all four values (High Reference, High Reading, Low reference, & Low reading) have been entered, the Adjust button will become active. Press the Adjust button to check and accept the calibration data then press the Save button. The instrument will then prompt with the question “Save Cal Data?”. Pressing the check mark [] in this screen will save the calibration to the memory of the transducer.

0019104001D 10/2018EN

9. Maintenance and Recalibration

9.2.9 Linearization



The Linearize Application provides a place to record upscale and downscale calibration data and to linearize each transducer using that data. An “as found calibration” can be performed by connecting a suitable pressure standard to the Measure/Control port of the CPC7000 being calibrated, and supplying between 3 and 11 pressure points across the complete range. The pressure points may be entered using both upscale and downscale pressure points, or only one direction. The record of the pressures from the pressure standard and the corresponding reading from the instrument’s transducer can be recorded and transcribed into the Linearization Matrix. Linearization of each transducer can be performed by selecting each transducer range from the setup screen.

EN



Figure 9.2.9-A Linearization App Data Matrix

The Linearization Application automatically populates the screen with equidistant increments from the low to high pressure corresponding to the range of the transducer selected. These values can be changed to reflect the values generated by the reference standard and the corresponding readings taken from the CPC7000. Each value from the reference standard can be entered under the reference column, corresponding Upscale and Downscale readings from the instrument can be entered in the “Actual” column or “Upscale” and “Downscale” columns. To enter a value simply press the number and a key pad will appear where the number can be entered. Press the check mark [✓] to accept each value. With upscale and downscale on, the “Average” column automatically averages the upscale and downscale values.

When satisfied that all values have been entered correctly, press the adjust button and then the save button to save the new calibration data in the transducer memory.

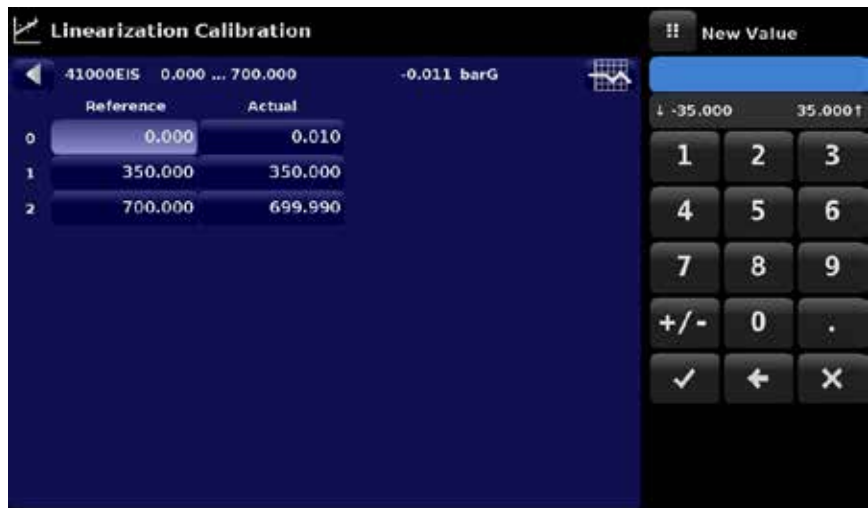



Figure 9.2.9-B Linearization Values

0019104001D 10/2018 EN

9. Maintenance and Recalibration

Figure 9.2.9-B shows some typical values that might be seen in a linearization calibration. In the bottom right hand corner of this screen is the Graph Icon [] that, when pressed, reveals a Linearization Error Graph (figure 9.2.9-C) that gives a visual representation of the errors associated with the values entered in the Linearization screen.

EN

This Linearization error graph shows a scaling that corresponds to the maximum error calculated from the data entered in the Linearization Matrix. It is a good indication of the overall error of the transducer, and will quickly reveal any gross data entry errors that have been made. To revert back to the Linearization Matrix press the Matrix Icon [].

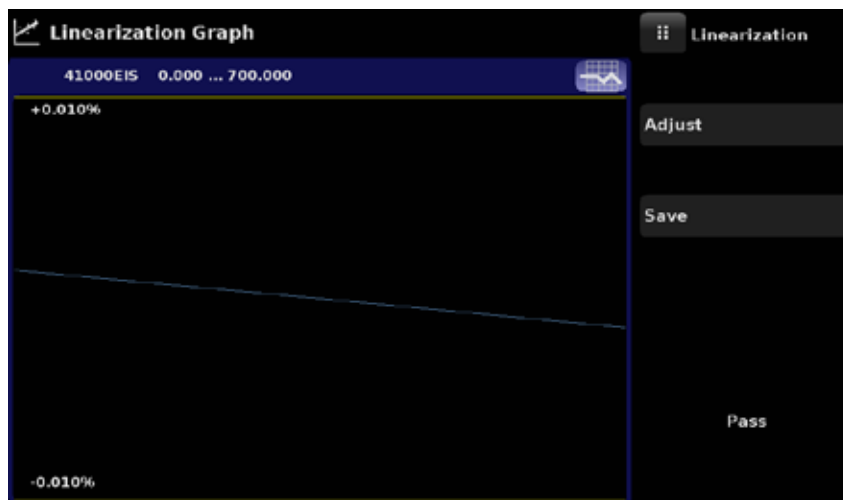

Figure 9.2.9-C Linearization Values



Note: After calibration is complete, return to the Calibration Data Application (Section 9.6) to record the certificate number, calibration interval and the date of calibration. Restoration to factory calibration can also be completed in this application

9.2.10 Head Pressure



The Head Pressure Application provides an automated way to calculate the head pressure offset between a device being tested and the CPC7000 transducer, based on

- Media: pneumatic
- Height: the difference between the device under test and the transducers in the CPC7000 (Difference = CPC7000-DUT)
- Gas Density: the density of the pressure media
- Gas Temperature
- Local Gravity

The Head Pressure application is placed under the password protected area of the operator interface to safeguard against inadvertent activation. It is intended to be used to accurately measure the pressure at an external source that is at a different elevation from the CPC7000 transducer sensing that pressure.

The four parameters are used to calculate the pressure that is a result of the different elevations. It should not be used when calibrating CPC7000 transducers. The Head height should be set at zero before calibrating the transducers of the CPC7000.

9. Maintenance and Recalibration



The Head Pressure should not be active when calibrating CPC7000 transducers. The Head height should be set at zero before calibrating the transducers of the CPC7000. Difference in height between the laboratory standard and the CPC7000 during calibration should be factored into the uncertainty analysis.

EN

Figure 9.2.10 shows the Head Pressure pneumatic screen. The height, media density (Nitrogen or dry air), media temperature and local gravity can be entered here based on the specific setup of the system.

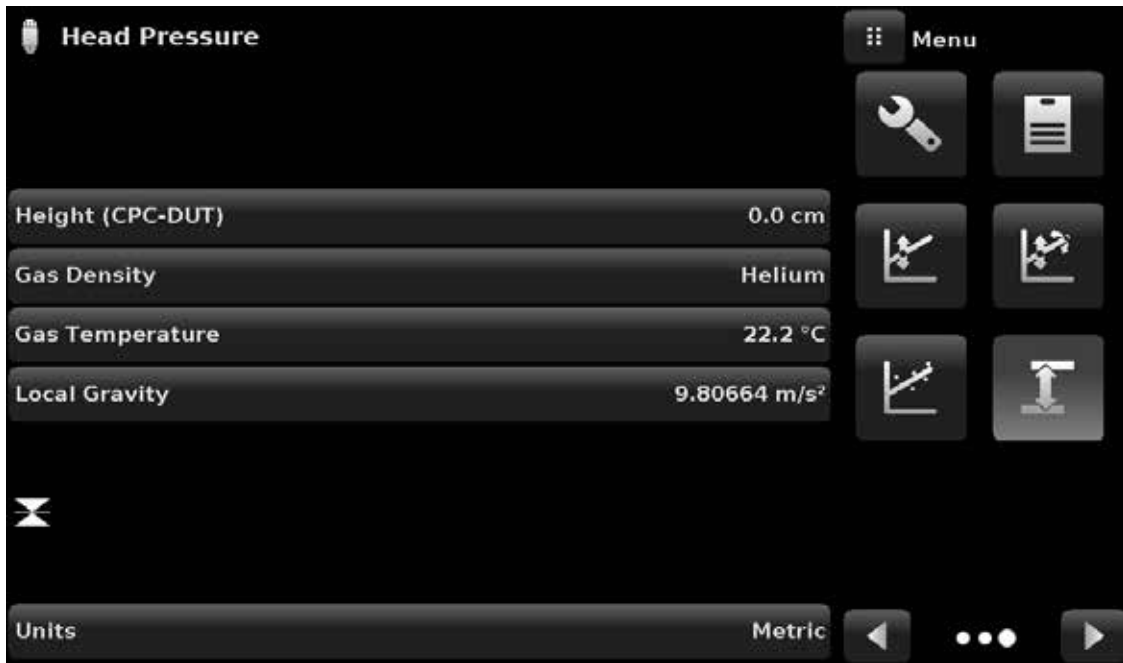

Figure 9.2.10 Head Pressure App

10. Dismounting, Return and Disposal

10. Dismounting, Return and Disposal

EN



WARNING!

Physical injuries and damage to property and the environment through residual media

Residual media in the dismantled instrument can result in a risk to persons, the environment and equipment.

- ▶ Wear the requisite protective equipment (see chapter 3.6 “Personal protective equipment”).
- ▶ Observe the information in the material safety data sheet for the corresponding medium.
- ▶ Wash or clean the dismantled instrument, in order to protect persons and the environment from exposure to residual media.

10.1 Dismounting



WARNING!

Physical injuries and damage to property and the environment through residual media

Upon contact with hazardous media (e.g. oxygen, acetylene, flammable or toxic substances), harmful media (e.g. corrosive, toxic, carcinogenic, radioactive), and also with refrigeration plants and compressors, there is a danger of physical injuries and damage to property and the environment.

- ▶ Before storage of the dismantled instrument (following use) wash or clean it, in order to protect persons and the environment from exposure to residual media.
- ▶ Wear the requisite protective equipment (see chapter 3.6 “Personal protective equipment”).
- ▶ Observe the information in the material safety data sheet for the corresponding medium.



WARNING!

Risk of burns

During dismantling there is a risk of dangerously hot media escaping.

- ▶ Let the instrument cool down sufficiently before dismantling it!



DANGER!

Danger to life caused by electric current

Upon contact with live parts, there is a direct danger to life.

- ▶ The dismantling of the instrument may only be carried out by skilled personnel.
- ▶ Only disconnect the pressure measuring instrument/measuring assembly/test and calibration installations once the system has been disconnected from the power!



WARNING!

Physical injury

When dismantling, there is a danger from aggressive media and high pressures.

- ▶ Wear the requisite protective equipment (see chapter 3.6 “Personal protective equipment”).
- ▶ Observe the information in the material safety data sheet for the corresponding medium.
- ▶ Only disconnect the pressure measuring instrument/measuring assembly/test and calibration installations once the system has been depressurised.

10. Dismounting, Return and Disposal

EN

10.2 Return

Strictly observe the following when shipping the instrument:

All instruments delivered to WIKA must be free from any kind of hazardous substances (acids, bases, solutions, etc.) and must therefore be cleaned before being returned.



WARNING!

Physical injuries and damage to property and the environment through residual media

Residual media in the dismantled instrument can result in a risk to persons, the environment and equipment.

- ▶ With hazardous substances, include the material safety data sheet for the corresponding medium..

When returning the instrument, use the original packaging or a suitable transport packaging.

To avoid damage:

1. Wrap the instrument in an antistatic plastic film.
2. Place the instrument along with shock-absorbent material in the packaging.
Place shock-absorbent material evenly on all sides of the transport packaging.
3. If possible, place a bag containing a desiccant inside the packaging.
4. Label the shipment as carriage of a highly sensitive measuring instrument.



Information on returns can be found under the heading "Service" on our local website.

10.3 Disposal

Incorrect disposal can put the environment at risk.

Dispose of instrument components and packaging materials in an environmentally compatible way and in accordance with the country-specific waste disposal regulations.



This marking on the instruments indicates that they must not be disposed of in domestic waste. The disposal is carried out by return to the manufacturer or by the corresponding municipal authorities.

11. Specifications

EN

11. Specifications

Accuracy specifications presented herein are obtained by comparison with primary standards traceable to a national metrology institute or recognized international standard organization. These specifications are obtained in accordance with the ISO Guide to the Expression of Uncertainty in Measurement (GUM). The calibration program at Mensor is accredited by the American Association of Laboratory Accreditation (A2LA) as complying with both the ISO/IEC 17025:2005 and the ANSI/NCSL Z540-1-1994 standards. If there is an exception to the requirements and recommendations of Z540 during a calibration the exception is noted on the individual calibration certificate.

Mensor reserves the right to change specifications without notice.

11.1 Measure Specification

Reference pressure transducers		
Pressure range	CPR8000	CPR8050
Accuracy ¹⁾	Standard: 0.01 % FS ²⁾ Option: 0.01 % IS-50 ³⁾	0.01 % FS ²⁾
Gauge pressure	100 ... 400 bar (1,500 ... 6,000 psi) ⁴⁾	400 ... 700 bar (6,000 ... 10,000 psi) ⁴⁾
Absolute pressure	101 ... 401 bar abs. (1,515 ... 6,015 psi abs.) ⁴⁾	401 ... 701 bar abs. (6,015 ... 10,015 psi abs.) ⁴⁾
Calibration interval	365 days	365 days
Optional barometric reference sensor		
Function	The barometric reference sensor can be used to switch pressure types ⁵⁾ , absolute <=> gauge.	
Measuring range	552 ... 1,172 mbar abs. (8 ... 17 psi abs.)	
Accuracy ¹⁾	0.01 % of reading	
Pressure units	39 and two freely programmable	

- 1) It is defined by the total measurement uncertainty, with the coverage factor (k = 2) and includes the intrinsic performance of the instrument, the measurement uncertainty of the reference instrument, long-term stability, influence of ambient conditions, drift and temperature effects over the compensated range with recommended zero point adjustment every 30 days.
- 2) FS = full span
- 3) 0.01 % IS-50 accuracy: Between 0 ... 50 % of the full scale, the accuracy is 0.01% of half of the full scale value and between 50 ... 100 % of the full scale, the accuracy is 0.01 % of reading.
- 4) Ranges from 1500 to 2000 psig will be sealed gauge transducers.
- 5) For a pressure type emulation, we recommend a native absolute pressure transducer, since the zero point drift can be eliminated through a zero point adjustment.

11.2 Base Instrument

Base Instrument	
Instrument	
Instrument version	Standard: desktop Option: 19" rack-mounting kit
Dimensions	See technical drawings
Weight	approx. 40 kg (88.2 lbs) incl. all internal options
Warm-up time	approx. 15 min
Display	
Screen	8.9" color LCD with resistive touchscreen
Resolution	4 ... 6 digits depending on range and units
Connections	
Pressure connections	Standard: 5 ports with M16 x 1.5 female with sealing cone Optional: 2 ports with 9/16-18 UNF female Optional barometer: M12 x 1 female thread
Filter elements	The instrument has a 20-micron filters on all pressure ports.

0019104001D 10/2018EN

11. Specifications

Permissible pressure media	Nitrogen 2.8 class or better
Overpressure protection	Burst disc up to 1,000 bar (14,500 psi)
Permissible pressure	
Supply port	107 ... 110 % FS or 30 ... 50 bar (435 ... 725 psi) over nominal pressure, whichever is greater
Measure/Control port	max 105 % FS
Voltage supply	
Power supply	100-120/200-240V, 50/60 Hz
Power consumption	max. 140 VA
Permissible ambient conditions	
Storage temperature	0 ... 70 °C (32 ... 158 °F)
Humidity	5 ... 95 % r. h. (relative humidity non-condensing)
Compensated temperature range	15 ... 45 °C (59 ... 113 °F)
Mounting position	horizontal
Control parameter	
Control stability	< 0.008 % FS in a 25 ml test volume
Control time	30 s ⁵⁾
Control range	0 ... 100 % FS
Minimum control pressure	1 bar (14.5 psi)
Test volume	0 ... 50 ccm
Communication	
Interface	Standard: Ethernet, IEEE-488, USB, RS-232.
Command sets	Mensor and WIKA SCPI
Response time	approx. 100 ms
Internal program	up to 24 sequences with up to 99 steps each

- 1) It is defined by the total measurement uncertainty, with the coverage factor (k = 2) and includes the intrinsic performance of the instrument, the measurement uncertainty of the reference instrument, long-term stability, influence of ambient conditions, drift and temperature effects over the compensated range with recommended zero point adjustment every 30 days.
- 2) FS = full span
- 3) 0.01 % IS-50 accuracy: Between 0 ... 50 % of the full scale, the accuracy is 0.01% of half of the full scale value and between 50 ... 100 % of the full scale, the accuracy is 0.01 % of reading.
- 4) For a pressure type emulation, we recommend a native absolute pressure transducer, since the zero point drift can be eliminated through a zero point adjustment.
- 5) Regarding a 10% FS pressure increase in 25 ml test volume

11.3 Approvals and Certificates

Certificate

Calibration ⁶⁾	Standard: 3.1 factory calibration certificate Option: DKD/DAkkS calibration certificate
---------------------------	--

- 6) Calibration in a horizontal position/operating position.

EN

11. Specifications

11.4 Dimensions in mm (in)

11.4.1 Desktop

EN

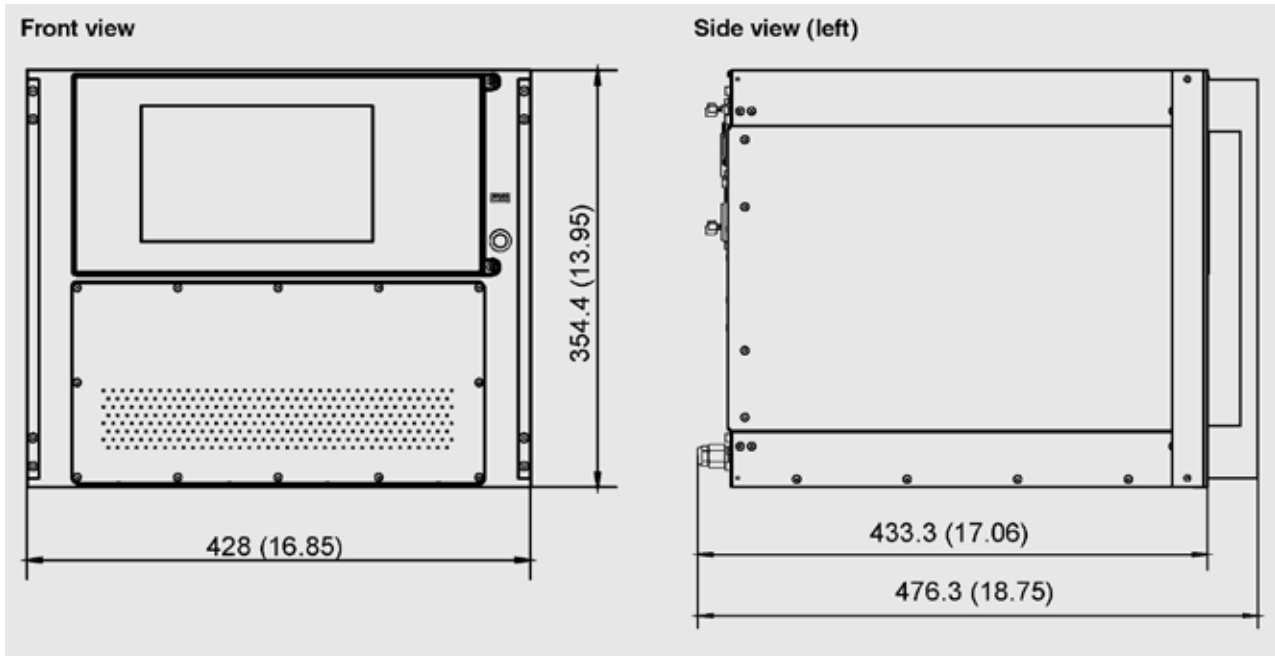

11.4.2 19" Rackmount

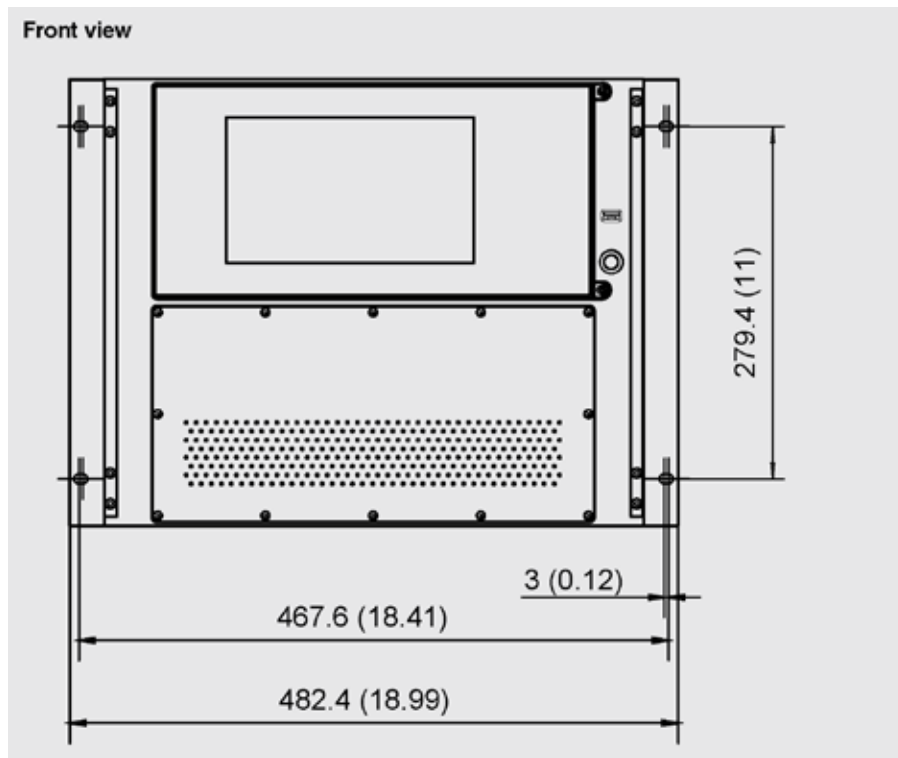

0019104001D 10/2018EN

12. Accessories

- Barometric reference sensor (for gauge or absolute emulation)
- Additional transducers
- Rack mounting kit
- Fittings
- Pressure booster

12.1 Barometric Reference Sensor

The CPC7000 can be ordered with a barometric reference sensor. It is a very stable, absolute pressure transducer, used to accurately measure local atmospheric pressure. It is used to display the barometric pressure (reading appears on the bottom right side of the display) or as a barometric reference for gauge or absolute emulation.

12.1.1 Gauge Pressure Emulation

In the Home Application (main screen) an absolute transducer will indicate “Absolute” in the Pressure Type button (this is the default mode). When the Pressure Type button is pressed the button label will toggle to “Gauge” and have a lighter background color. The lighter background color is an indication that the instrument is in emulation mode.

In the gauge emulation mode the atmospheric pressure reading from the barometric reference transducer is subtracted from the absolute pressure reading of the instrument to emulate a gauge pressure.

The barometric reference transducer has six significant digits. If a very low pressure gauge transducer is active and is used in absolute emulation, the combined output may appear quite noisy because of the resolution of the barometric reference.

12.1.2 Absolute Pressure Emulation

In the Home Application (main screen) a gauge transducer will indicate “Gauge” in the Pressure Type button (this is the default mode). When the Pressure Type button is pressed the button label will toggle to “Absolute” and have a lighter button background color. The lighter background color is an indication that the instrument is in emulation mode.

In the absolute emulation mode the atmospheric pressure reading from the barometric reference transducer is added to the gauge pressure reading of the instrument to emulate an absolute pressure. The instrument is only able to emulate absolute pressures above atmospheric pressure. Sub-atmospheric control is not possible.

12.1.3 Emulation Mode Accuracy

The accuracy in emulation mode is different for gauge and absolute emulation mode.

The barometric reference has six significant digits and has a guaranteed drift of 0.0000041 psi over a 24 hour period which has no significant effect on the emulated gauge pressure uncertainty.

The absolute uncertainty of the barometric reference must be considered in the emulated absolute pressure uncertainty.

12.1.4 Barometric Reference Calibration

The Barometric Reference Transducer can be calibrated in exactly the same manner as the other installed transducers as described in Section 9.2 Recalibration.

12.2 Additional Transducers

A secondary transducer and a tertiary transducer of any standard range, can be purchased as an option. In all other regards, the add-on transducer will meet all of the specifications and operating parameters outlines throughout this manual.

The tertiary transducer must be within the range of the secondary transducer and the secondary transducer must be within the range of the primary transducer installed in the instrument.

13. Appendix

12.3 19" Rackmount

A rack mount kit allows the customer to install a CPC7000 into a standard 19" instrument rack. It includes mounting tabs to the front panel of the instrument to secure it in the rack mount as shown in Section 11.4.2.

EN



WARNING!

Rack mounting the CPC7000 involves placing the instrument on to a platform and securing it in place with provided mounting tabs. It is recommended to install the instrument with a sturdy base/platform that can sustain up to 40 kg / 88.2 lbs of weight.

12.4 Fittings

The 9/16-18 UNF female adapters can be purchased as an option to the standard M16 x 1.5 female adapters.

12.5 Pressure Booster

To control pressure, the CPC7000 requires a pressure supply of 10% above the full scale of the instrument. The Model 77 Pressure Booster System provides the ability to boost bottle pressure up to the supply pressure requirements of all possible CPC7000 range configurations while maximizing gas bottle/cylinder usage.

The Model 77 is a single piston air driven gas booster mounted in a heavy duty roll bar frame. The unit includes an operator control panel with gauges for supply pressure, output reference pressure and an output vent valve. The system requires shop air to drive the booster and a minimum of 300 psi to 3000 psi maximum inlet pressure (clean dry air or Nitrogen).

Table 12.5 Pressure Booster Specifications

Input Supply Pressure	Minimum: 300 psi Maximum: 3000 psi Media: Clean Dry Inert Gas (Nitrogen preferred)
Output Pressure	10,000 psi typical 14,000 psi relief valve setting



Figure 12.5 Model 77 Pressure Booster

13. Appendix

13.1 Measurement Units

Table 13.1 Measurement Units (unitno)

Code	Description	Output Format
1	pounds per square inch	psi
2	inches of mercury @ 0°C	in Hg 0°C
3	inches of mercury @ 60°F	in Hg 60°F
4	inches of water @ 4°C	in H2O 4°C
5	inches of water @ 20°C	in H2O 20°C
6	inches of water @ 60°F	in H2O 60°F
7	feet of water @ 4°C	ft H2O 4°C
8	feet of water @ 20°C	ft H2O 20°C
9	feet of water @ 60°F	ft H2O 60°F
10	millitorr	mTorr
11	inches of seawater @ 0°C 3.5% salinity	in SW
12	feet of seawater @ 0°C 3.5% salinity	ft SW
13	atmospheres	atm
14	bars	bar
15	millibars	mbar
16	millimeters of water @ 4°C	mm H2O 4°C
17	centimeters of water @ 4°C	cm H2O 4°C
18	meters of water @ 4°C	m H2O 4°C
19	millimeters of mercury @ 0°C	mm Hg 0°C
20	centimeters of mercury @ 0°C	cm Hg 0°C
21	torr	Torr
22	kilopascals	kPa
23	pascals	Pa
24	dyne per square centimeter	dyn/cm2
25	grams per square centimeter	g/cm2
26	kilograms per square centimeter	kg/cm2
27	meters of seawater @ 0°C 3.5% salinity	m SW
28	ounce per square inch	osi
29	pounds per square foot	pfs
30	tons per square foot	tsf
31	percent of full scale	% of Range
32	micron of mercury @ 0°C	mHg
33	ton per square inch	tsi
34	meters of mercury @ 0°C	MHg
35	hectopascals	hPa
36	megapascals	MPa
37	millimeters of water @ 20°C	mm H2O 20°C
38	centimeter of water @ 20°C	cm H2O 20°C
39	meters of water @ 20°C	m H2O 20°C
n/a	User Units 1	User defined

EN

13. Appendix

n/a User Units 2

User defined

13.2 Conversion Factors, PSI

The values listed in the column "To convert from PSI" are the values imbedded in the instrument program. The values listed under "To convert to PSI" are internally calculated approximations based on the imbedded values.

Table 13.2 Conversion Factors, PSI

Code	Pressure Unit	To convert from PSI	To convert to PSI
1	PSI	1	1
2	inHg 0°C	2.036020	0.4911544
3	inHg 60°F	2.041772	0.4897707
4	inH2O 4°C	27.68067	0.03612629
5	inH2O 20°C	27.72977	0.03606233
6	inH2O 60°F	27.70759	0.03609119
7	ftH2O 4°C	2.306726	0.4335149
8	ftH2O 20°C	2.310814	0.4327480
9	ftH2O 60°F	2.308966	0.4330943
10	mTorr	51715.08	0.00001933672
11	inSW 0°C 3.5% salinity	26.92334	0.03714250
12	ftSW 0°C 3.5% salinity	2.243611	0.445710
13	ATM	0.06804596	14.69595
14	Bar	0.06894757	14.50377
15	mBar	68.94757	0.01450377
16	mmH2O 4°C	703.0890	0.001422295
17	cmH2O 4°C	70.30890	0.01422295
18	MH2O 4°C	0.7030890	1.422295
19	mmHg 0°C	51.71508	0.01933672
20	cmHg 0°C	5.171508	0.1933672
21	Torr	51.71508	0.01933672
22	kPa	6.894757	0.1450377
23	PA	6894.757	0.0001450377
24	Dy/cm2	68947.57	0.00001450377
25	gm/cm2	70.30697	0.01422334
26	kg/cm2	0.07030697	14.22334
27	MSW 0°C 3.5% salinity	0.6838528	1.462303
28	OSI	16	0.0625
29	PSF	144	0.006944444
30	TSF	0.072	13.88889
32	μHg 0°C	51715.08	0.00001933672
33	TSI	0.0005	2000
34	mHg 0°C	0.05171508	19.33672
35	hPa	68.94757	0.01450377
36	MPa	0.006894757	145.0377
37	mmH2O 20°C	704.336	0.001419777
38	cmH2O 20°C	70.4336	0.01419777
39	MH2O 20°C	0.704336	1.419777

EN

0019104001D 10/2018EN

13. Appendix

13.3 Conversion Factors, Millitorr

The following table lists factors which should be used as multipliers when converting other pressure units to or from millitorr.

Table 13.3 Conversion Factors, Millitorr

Code	Pressure Unit	To convert from millitorr	To convert to millitorr
1	PSI	0.0001933672	51715.08
2	inHg 0°C	0.00003936995	25400.08909
3	inHg 60°F	0.00003948117	25328.53093
4	inH2O 4°C	0.0005352534	1868.273977
5	inH2O 20°C	0.0005362028	1864.966281
6	inH2O 60°F	0.0005357739	1866.458778
7	ftH2O 4°C	0.00004460451	22419.25773
8	ftH2O 20°C	0.00004468356	22379.59744
9	ftH2O 60°F	0.00004464783	22397.50637
10	mTorr	1.0	1.000000000
11	inSW 0°C 3.5% salinity	0.0005206091	1920.827359
12	ftSW 0°C 3.5% salinity	0.00004338408	23049.92831
13	ATM	0.000001315786	760002.2299
14	Bar	0.000001333220	750063.6259
15	mBar	0.001333220	750.0636259
16	mmH2O 4°C	0.0135954	73.5540997
17	cmH2O 4°C	0.001359544	735.5409971
18	MH2O 4°C	0.00001359544	73554.09971
19	mmHg 0°C	0.001	1000.000000
20	cmHg 0°C	0.0001	10000.00000
21	Torr	0.001	1000.000000
22	kPa	0.0001333220	7500.636259
23	PA	0.1333220	7.500636259
24	Dy/cm2	1.333220	0.750063626
25	gm/cm2	0.001359506	735.561166
26	kg/cm2	0.000001359506	735561.166
27	MSW 0°C 3.5% salinity	0.00001322347	75623.11663
28	OSI	0.0003093875	3232.1992
29	PSF	0.002784488	359.132477
30	TSF	0.000001392244	718265.0575
32	μHg 0°C	1.0	1.000000000
33	TSI	0.00000000966836	103430160.00
34	mHg	0.000001	1000000.00
35	hPa	0.001333220	750.0636259
36	MPa	0.0000001333220	7500636.259
37	mmH2O 20°C	0.01361955	73.42388114
38	cmH2O 20°C	0.001361955	734.2388114
39	MH2O 20°C	0.00001361955	73423.88114

EN

0019104001D 10/2018 EN

13. Appendix

13.4 Conversion Factors, Pascal

The following table lists factors which should be used as multipliers when converting other pressure units to or from Pascal.

Table 13.4 Conversion Factors, Pascal

EN	Unit No.	Pressure Unit	To convert from Pascal	To convert to Pascal
	1	PSI	1.450377E-04	6.894757E+03
	2	inHg 0°C	2.952997E-04	3.386390E+03
	3	inHg 60°F	2.961339E-04	3.376850E+03
	4	inH2O 4°C	4.014741E-03	2.490820E+02
	5	inH2O 20°C	4.021862E-03	2.486410E+02
	6	inH2O 60°F	4.018645E-03	2.488400E+02
	7	ftH2O 4°C	3.345622E-04	2.988980E+03
	8	ftH2O 20°C	3.351551E-04	2.983692E+03
	9	ftH2O 60°F	3.348871E-04	2.986080E+03
	10	mTorr	7.500636E+00	1.333220E-01
	11	inSW 0°C 3.5% sal	3.904899E-03	2.560885E+02
	12	ftSW 0°C 3.5% sal	3.254082E-04	3.073062E+03
	13	ATM	9.869230E-06	1.013250E+05
	14	Bar	1.00000E-05	1.00000E+05
	15	mBar	1.00000E-02	1.00000E+02
	16	mmH2O 4°C	1.019744E-01	9.806378E+00
	17	cmH2O 4°C	1.019744E-02	9.806378E+01
	18	MH2O 4°C	1.019744E-04	9.806378E+03
	19	mmHg 0°C	7.500636E-03	1.333220E+02
	20	cmHg 0°C	7.500636E-04	1.333220E+03
	21	Torr	7.500636E-03	1.333220E+02
	22	kPa	1.00000E-03	1.00000E+03
	23	PA	1.00000E+00	1.00000E+00
	24	Dy/cm2	1.00000E+01	1.00000E-01
	25	gm/cm2	1.019716E-02	9.806647E+01
	26	kg/cm2	1.019716E-05	9.806647E+04
	27	MSW 0°C 3.5% sal	9.918444E-05	1.008222E+04
	28	OSI	2.320603E-03	4.309223E+02
	29	PSF	2.088543E-02	4.788025E+01
	30	TSF	1.044271E-05	9.576052E+04
	32	μHg 0°C	7.500636E+00	1.333220E-01
	33	TSI	7.251885E-08	1.378951E+07
	34	mHg 0°C	7.500636E-06	1.333220E+05
	35	hPa	1.00000E-02	1.00000E+02
	36	MPa	1.00000E-06	1.00000E+06
	37	mmH2O 20°C	1.021553E-01	9.789017E+00
	38	cmH2O 20°C	1.021553E-02	9.789017E+01
	39	MH2O 20°C	1.021553E-04	9.789017E+03

WIKA subsidiaries worldwide can be found online at www.wika.com.



Mensor Corporation
201 Barnes Drive
San Marcos, TX 78666 • USA
Tel. (+1) 512 3964200-15
Fax (+1) 512 3961820
E-Mail sales@mensor.com
www.mensor.com



WIKAI Alexander Wiegand SE & Co. KG
Alexander-Wiegand-Straße 30
63911 Klingenberg • Germany
Tel. +49 9372 132-0
Fax +49 9372 132-406
info@wika.de
www.wika.de

0019104001C 09/2018EN