

Digital pressure gauge Basic version Model CPG500

WIKA data sheet CT 09.01



for further approvals
see page 3

Applications

- Calibration service companies and service industry
- Measurement and control laboratories
- Quality assurance
- Simple calibrations directly on-site

Special features

- Measuring ranges from -1 ... +16 bar to 0 ... 1,000 bar [-14.5 ... 230 psi to 0 ... 14,500 psi]
- Accuracy: 0.25 % (incl. calibration certificate)
- Robust case with protective rubber cap
- Simple operation using four buttons
- Complete service cases available incl. pressure generation



Digital pressure gauge, model CPG500

Description

General information

The model CPG500 digital pressure gauge enables the measurement and display of pressure values in a single instrument. The accuracy of digital measurement technology and the simplicity of an analogue gauge are combined in this instrument.

Accuracy

The CPG500 offers an accuracy of 0.25 % of span in eight pressure measuring ranges. Readings can be displayed in one of five standard units.

Sampling rate

With a measuring rate of 100 measurements per second, the CPG500 features a very high measuring rate. With this, fast pressure spikes and drops in pressure can be detected. The bar graph display and drag pointer function integrated into the display, as well as retrievable Min./Max. peak values, enable effective analysis of the measuring location.

Features

In order to prolong the battery life, the CPG500 features an automatic switch-off function.

With the Zero function, the display value can be zeroed with the simple press of a button.

A filter function (which can be activated) stabilises pressures which fluctuate strongly, and enables the pressure value to be read easily.

Complete test and service cases

For maintenance and service applications, various case systems are available. Service cases with pneumatic or hydraulic pressure generation are available.

Certified accuracy

For each digital pressure gauge, the accuracy is certified by a factory calibration certificate which accompanies the instrument. On request, a DAkkS calibration certificate will be provided for this instrument.

**Specifications
Model CPG500**

Sensor technology		
Measuring range	bar	psi
Gauge pressure	-1 ... 16 bar	-14.5 ... 230 psi
Resolution	0.001	
Gauge pressure	-1 ... 20 bar	-14.5 ... 290 psi
	-1 ... 40 bar	-14.5 ... 580 psi
	0 ... 60 bar	0 ... 870 psi
	0 ... 100 bar	0 ... 1,540 psi
Resolution	0.01	
Gauge pressure	0 ... 350 bar	0 ... 5,000 psi
	0 ... 700 bar	0 ... 10,000 psi
	0 ... 1,000 bar	0 ... 14,500 psi
Resolution	0.1	
Overload safety	3 times; < 25 bar 2 times; > 25 bar ... ≤ 600 bar 1.5 times; > 600 bar	3 times; < 360 psi 2 times; > 360 psi ... ≤ 8,700 psi 1.5 times; > 8,700 psi
Pressure connection	G ¼ B up to a max. 40 bar [580 psi] G ½ B from > 40 bar [> 580 psi]	
Accuracy	0.25 % FS ±1 digit	

Base instrument	
Display	
Display	4 ½ digit, bar graph with drag pointer function, illuminated
Digit height	15 mm [0.59 in]
Rotatable case	> 270 °
Dimensions	50 x 34 mm [1.97 x 1.34 in]
Pressure units	<ul style="list-style-type: none"> ■ bar ■ psi ■ MPa ■ kPa
Functions	
Measuring rate	10 ms
Memory	Min./Max.
Autopower	Can be switched on and off
Zero function	Zero point adjustment
Reset	Delete Min./Max. value
Material	
Wetted parts ¹⁾	Stainless steel with NBR sealing
Case	Zinc die-cast with TPE protective rubber cap
Voltage supply	
Supply voltage	2 x 1.5 V AA batteries
Battery life	approx. 1,500 hrs
Battery status display	Icon in display

1) Only for use with safe media per directive 67/548/EEC (article 2, paragraph 2).







Base instrument	
Permissible ambient conditions	
Operating temperature	-10 ... +50 °C [14 ... 122 °F]
Medium temperature range	-20 ... +80 °C [-4 ... +176 °F]
Storage temperature range	-20 ... +60 °C [-4 ... +140 °F]
Relative humidity	< 85 % r. h. (non-condensing)
Case	
Dimensions	79 x 79 x 33 mm [3.11 x 3.11 x 1.30 in]
Ingress protection	IP67
Weight	approx. 400 g [0.882 lbs]

Approvals

Approvals included in delivery

Logo	Description	Country
	EU declaration of conformity	European Union
	EMC directive EN 61326 emission (group 1, class B) and immunity (industrial application)	
	Pressure equipment directive	
	RoHS directive	

Optional approvals

Logo	Description	Country
	EAC	Eurasian Economic Community
	EMC directive	
	Pressure equipment directive	
	Uzstandard Metrology, measurement technology	Uzbekistan
	UkrSEPRO Metrology, measurement technology	Ukraine
	GOST Metrology, measurement technology	Russia
-	MTSCHS Permission for commissioning	Kazakhstan
	KazInMetr Metrology, measurement technology	Kazakhstan
-	CRN Safety (e.g. electr. safety, overpressure, ...)	Canada
	BelGIM Metrology, measurement technology	Belarus

Certificates

Certificate	
Calibration ¹⁾	<ul style="list-style-type: none">■ 3.1 inspection certificate per DIN EN 10204 (factory calibration)■ DAkkS calibration certificate (traceable and accredited in accordance with ISO/IEC 17025)
Recommended recalibration interval	1 year (dependent on conditions of use)

1) Calibrated in vertical mounting position with process connection facing downwards

→ Approvals and certificates, see website

Dimensions in mm [in]

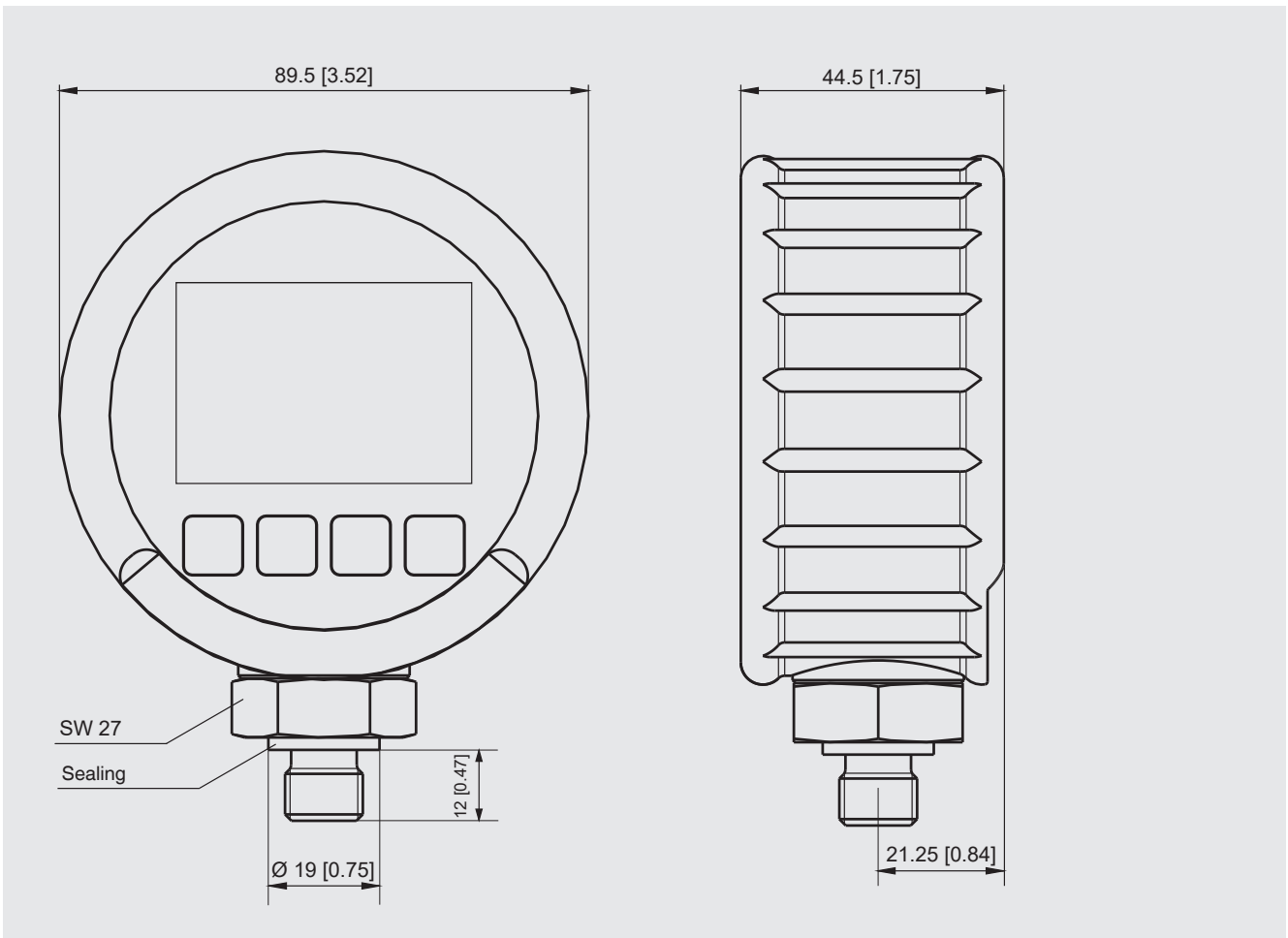

1) Drawing with G ¼ pressure connection

G ½ and G ¼ threaded connections

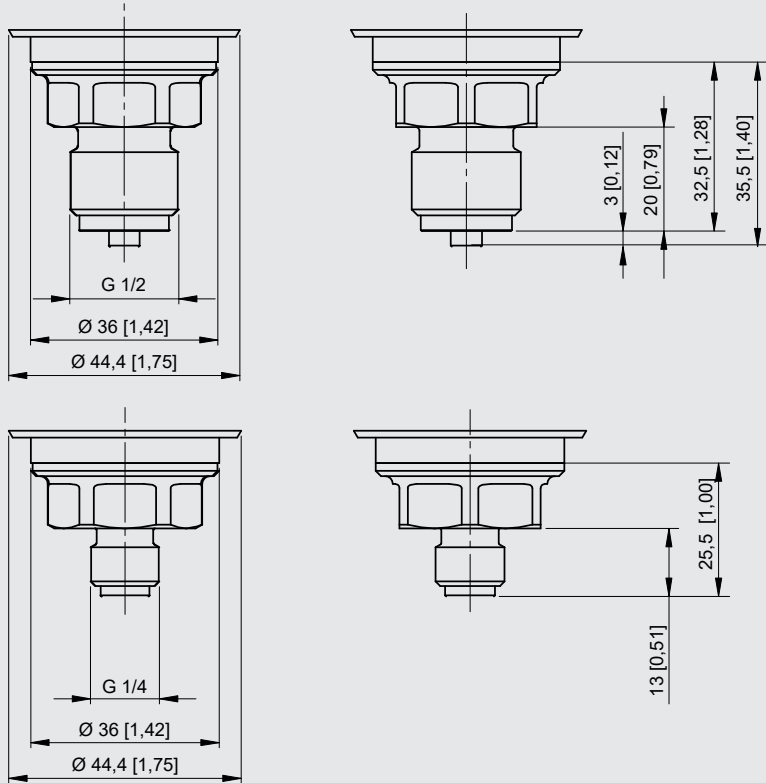

Front foil

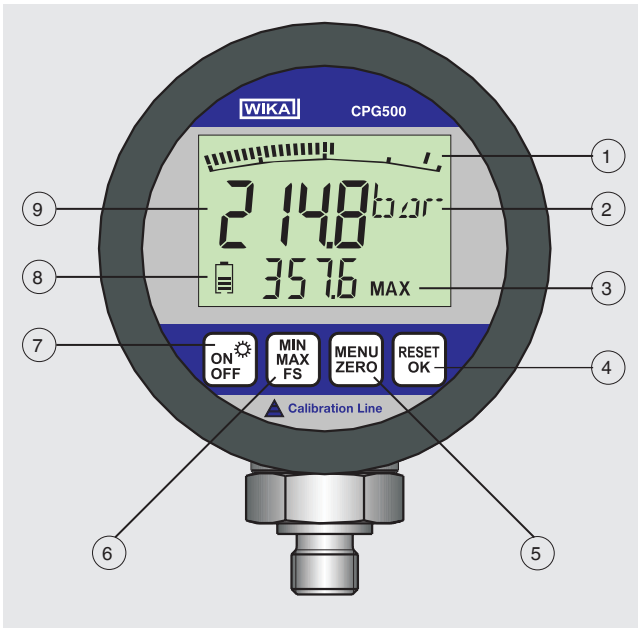

- ① Bar graph indicates the current pressure graphically
- ② Currently set unit
- ③ Display of the measuring range or the Min./Max. value
- ④ Clear the Min./Max. values
Confirmation function in the menu
- ⑤ Keep pressed to access the menu
Carry out zero point adjustment by pressing once
- ⑥ Change display value to Min./Max. or FS (Full Scale)
- ⑦ Switch the digital pressure gauge on/off by pressing once
Keep pressed in order to switch the backlighting on
- ⑧ Battery status
- ⑨ Display of current pressure

WIKA-Cal calibration software

Easy and fast creation of a high-quality calibration certificate

The WIKA-Cal calibration software is used for generating calibration certificates or logger protocols for pressure measuring instruments and is available as a demo version for a cost-free download.

To switch from the demo version to a licenced version, a USB dongle with a valid licence must be purchased.

The pre-installed demo version changes automatically to the selected version when plugging in the USB dongle and remains available as long as the USB dongle is connected to the PC.



- The user is guided through the calibration or logger process
- Management of calibration data and instrument data
- Intelligent preselection via SQL database
- Menu languages: German, English, Italian, French, Dutch, Polish, Portuguese, Romanian, Spanish, Swedish, Russian, Greek, Japanese, Chinese
More languages will be due with software updates
- Customer-specific complete solutions possible
- Maximum level of automation in connection with our CPC series

The supported instruments are continuously expanded and even customer-specific adaptations are possible.

For further information see data sheet CT 95.10

Two WIKA-Cal licences are available together with a digital pressure gauge

The WIKA-Cal calibration software is available both for reading the logger data stored in the digital pressure gauge as well as for online calibrations together with a PC. The scope of software functions depends on the selected licence.

Several licences can be combined on one USB dongle.

Cal-Template (light version)	Log-Template (full version)
<ul style="list-style-type: none"> ■ Semi-automatic creation of calibration certificates for mechanical and electronic pressure measuring instruments ■ Creation of 3.1 calibration certificates per DIN EN 10204 ■ Calibration reports can be exported to Excel® template or XML file 	<ul style="list-style-type: none"> ■ Live measured value recording for a certain period of time with selectable interval, duration and start time ■ Readout of the integrated data logger of the hand-held ■ Creation of logger protocols with graphic and/or tabular representation of the measuring results in PDF format ■ Possibility of exporting measuring results as CSV file
Ordering information for your enquiry:	
WIKA-CAL-LZ-Z-Z	WIKA-CAL-ZZ-L-Z
WIKA-CAL-LZ-L-Z	

Complete test and service cases

Calibration case with model CPG500 digital pressure gauge and model CPP40 hand test pump, for pressures -0.95 ... +40 bar [13.8 ... 580 psi], consisting of:

- Plastic service case with foam insert
- Digital pressure gauge model CPG500
- Pneumatic hand test pump model CPP40; -0.95 ... +40 bar [13.8 ... 580 psi]

Available measuring ranges see specifications



Basic version incl. pneumatic pressure generation

Calibration case with model CPG500 digital pressure gauge and model CPP700-H or CPP1000-H hand test pumps, for pressures 0 ... 700 bar [0 ... 10,000 psi] or 0 ... 1,000 bar [0 ... 14,500 psi], consisting of:

- Plastic service case with foam insert
- Digital pressure gauge model CPG500
- Hydraulic hand test pump model CPP700-H or CPP1000-H, 0 ... 700 bar [0 ... 10,000 psi] or 0 ... 1,000 bar [0 ... 14,500 psi]

Available measuring ranges see specifications



Basic version incl. hydraulic pressure generation

Recommended pressure generation

Pneumatic hand test pump model CPP40

Pressure range: -0.95 ... +40 bar [13.8 ... 580 psi]



Pneumatic hand test pump model CPP40

Hydraulic hand test pumps model CPP700-H or model CPP1000-H



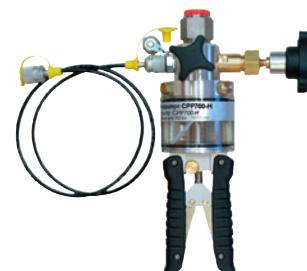

Pressure range: 0 ... 700 bar or 0 ... 1,000 bar
[0 ... 10,000 psi or 0 ... 14,500 psi]



Hydraulic hand test pumps model CPP700-H or model CPP1000-H

Further specifications see data sheet CT 91.07

Accessories

Description		Order code
Description		CPG-A-50-
	Pneumatic hand test pump model CPP40 Pressure range: -0.95 ... +40 bar [-13.8 ... 580 psi] Pressure connections 2 x G 1/4	-P-
	Maintenance set for hand test pump model CPP40 Consisting of 4 x screws, 1 x knurled wheel, 1 x square ring seal, 3 x O-ring seals, 1 x flat gasket and plastic box	-W-
	Spare hose for hand test pump model CPP40	-E-
	Sealing set Consisting of 4 x G 1/2 USIT sealings, 2 x G 1/4 USIT sealings and plastic box	-D-
	Plastic case For 1 x digital pressure gauge, 1 x pneumatic hand test pump CPP40, accessories	-L-
	Plastic case For 1 x digital pressure gauge, 1 x hydraulic hand test pump CPP700-H/CP1000-H, accessories	-N-
Ordering information for your enquiry:		
1. Order code: CPG-A-50 2. Option:		↓ []

Scope of delivery

- Digital pressure gauge model CPG500
- Operating instructions
- 3.1 calibration certificate per DIN EN 10204
- 2 x AA batteries
- Protective rubber cap for case

Option

- DAkkS-certified accuracy

Ordering information

Model / Unit / Measuring range / Process connection / Test pump / Transport case / Type of certificate / Further approvals / Additional ordering information

© 12/2011 WIKA Alexander Wiegand SE & Co. KG, all rights reserved.
 The specifications given in this document represent the state of engineering at the time of publishing.
 We reserve the right to make modifications to the specifications and materials.