

Bypass level indicator With magnetic display Model BNA for nuclear power plants

KSR data sheet BNA for NPP



Applications

- Continuous level indication without power supply
- Indication of the level proportional to height
- Individual design and corrosion resistant materials make the products suitable for a broad range of applications
- Chemical, petrochemical industry, oil and natural gas extraction (on- and offshore), shipbuilding, machine building, power generating equipment, power plants
- Process water and drinking water treatment, food industry, pharmaceutical industry

Special features

- Process- and system-specific production
- Operating limits:
 - Operating temperature: $T = -196 \dots +450 \text{ }^\circ\text{C}$
 - Operating pressure: $P = \text{vacuum to } 400 \text{ bar}$
 - Limit density: $\rho \geq 340 \text{ kg/m}^3$
- Wide variety of different process connections and materials
- Mounting of level sensors and magnetic switches possible as an option
- Explosion-protected versions

Description

The bypass level indicator model BNA consists of a bypass chamber, which, as a communicating tube, is connected laterally to a vessel via at least 2 process connections (flanged, threaded or welded). Through this type of arrangement, the level in the bypass chamber corresponds to the level in the vessel. The float with a built-in permanent magnetic system, which is mounted within the bypass chamber, transmits the liquid level, contact-free, to the magnetic display mounted to the outside of the bypass chamber. In this are fitted, at 10 mm intervals, two-coloured plastic rollers or stainless steel flaps with bar magnets.

Bypass level indicator, model BNA with level sensor and magnetic switch

Through the magnetic field of the permanent magnetic system in the float, the display elements, through the wall of the bypass chamber, are turned through 180° . For an increasing level from white to red; for a falling level from red to white.

Thus the bypass level indicator clearly displays the level of a vessel **without power supply**.



Further special features

- Simple, robust and solid design, long service life
- Bypass chamber and float from stainless steel 1.4571, 1.4404 or special materials
- Pressure- and gas-tight separation between measuring and display chamber
- Measuring and indicating of the level of aggressive, combustible, toxic, hot and contaminated media
- Functioning of the magnetic display guaranteed even in the case of power failures
- By using a variety of corrosion-resistant materials, applicable for virtually all industrial applications
- Continuous measurement of levels, independent of physical and chemical changes of the media such as: Foaming, conductivity, dielectric constant, vapours, bubble formation, boiling effects
- Interface-layer level measurement from Δ density 100 kg/m^3
- Special versions: Food compliant, coatings, liquid gas, heating jacket
- Nuclear qualified IEEE (E1)

Illustration of the principle

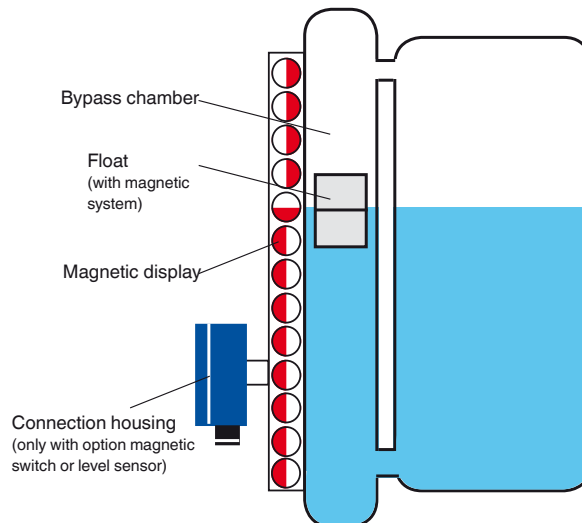

Design and operating principle

- In a communicating bypass chamber mounted to the side of a vessel a float moves with the level of the medium to be measured.
- The magnetic field of the radial-symmetric magnetic system positioned in the float activates the magnetic display attached to the outside of the bypass chamber as well as the switching and measuring elements.

Magnetic system

The magnetic system is assembled from a pole disc and various magnets. These can be individually adapted to the different chamber dimensions and for temperatures up to $450 \text{ }^\circ\text{C}$.

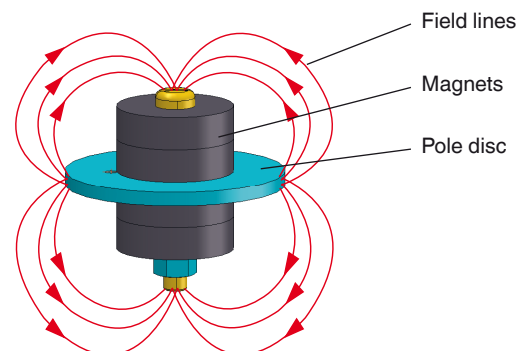

Model overview

Bypass level indicator	Approval								Material	Max. pressure in bar	Medium temperature in °C
	with-out	Ex c	Ex c, GL	Ex c, DNV	GL	DNV	ABS	IEEE 344			
Standard version, model BNA-S	x	x	x	x	x	x	x	x	Stainless steel 1.4571 (316Ti), 1.4404 (316L), 1.4401/1.4404 (316/316L)	64	-196 ... +450
High-pressure version, model BNA-H	x	x	x	x	x	x		*	Stainless steel 1.4571 (316Ti), 1.4404 (316L)	400	-196 ... +450
DUPlus version, standard, model BNA-SD	x	x						*	Stainless steel 1.4571 (316Ti), 1.4404 (316L), 1.4401/1.4404 (316/316L)	64	-196 ... +450
DUPlus version, high pressure, model BNA-HD	x	x						*	Stainless steel 1.4571 (316Ti), 1.4404 (316L), 1.4401/1.4404 (316/316L)	160	-196 ... +450
Special materials, model BNA-X	x	x						*	Stainless steel 6Mo 1.4547 (UNS S31254)	250	-196 ... +450
	x	x	x	x	x	x		*	Hastelloy C276 (2.4819)	160	-196 ... +450

* IEEE 344 on request

Ex approvals

Explosion protection	Ignition protection type	Model	Zone	Approval number
ATEX	Ex c	BNA-S, BNA-H, BNA-SD, BNA-HD, BNA-X	Zone 0/1, gas	KEMA 02 ATEX 2106 X II 1/2 G c T1 ... T6
	Ex c + GL	BNA-S, BNA-H, BNA-X	Zone 0/1, gas	KEMA 02 ATEX 2106 X II 1/2 G c T1 ... T6 + GL - 35 949 - 87
	Ex c + DNV	BNA-S, BNA-H, BNA-X	Zone 0/1, gas	KEMA 02 ATEX 2106 X II 1/2 G c T1 ... T6 + DNV - A-11451

Type approval

Approval	Model	Approval number
GL	BNA-S, BNA-H, BNA-X	GL - 35 949 - 87 HH
DNV	BNA-S, BNA-H, BNA-X	DNV A-11451
ABS	BNA-S	ABS 07-HG218425-1-PDA
GOST-R	all	0959333
IEEE 344	BNA-S	-

Further approvals on request

Detailed information on floats, magnetic displays, sensors (reed chains and magnetostrictive) and magnetic switches can be found in the following data sheets:

- Float; model BFT; see data sheet LM 10.02
- Magnetic display; model BMD; see data sheet LM 10.03
- Reed sensor; model BLR; see data sheet LM 10.04
- Magnetostrictive sensor; model BLM; see data sheet LM 10.05
- Magnetic switch; model BGU; see data sheet LM 10.06

Bypass level indicator, standard version, model BNA-S

Bypass chamber from stainless steel

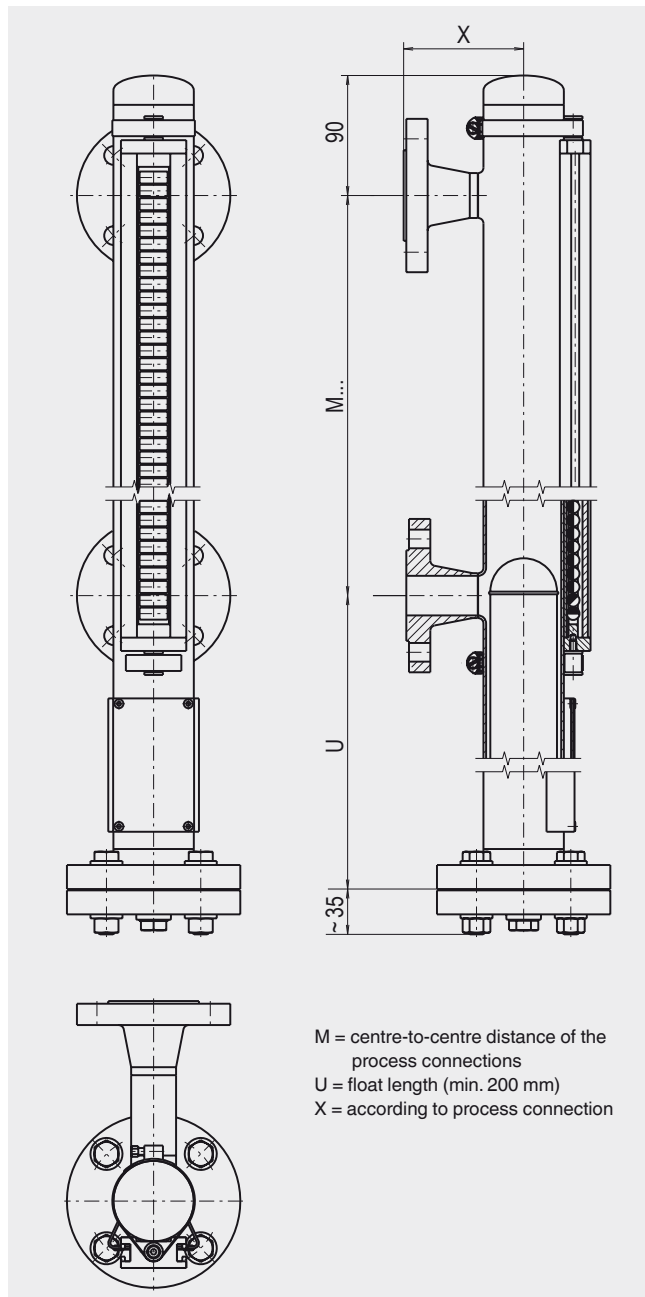

Specifications

Bypass chamber	Ø 60.3 x 2 mm, max. 40 bar Ø 60.3 x 2.77 mm, max. 64 bar
Chamber end top	Flat top or flange connection Options: (see page 14) ■ Vent screw ■ Vent valve ■ Vent flange
Chamber end bottom	Flange connection Options: (see page 14) ■ Drain plug ■ Drain valve ■ Drain flange
Process connections	2 x lateral (options see page 15) Flange EN 1092-1, DN 10 - DN 100, PN 6 - PN 63 Flange DIN, DN 10 - DN 100, PN 6 - PN 64 Flange ANSI B 16.5, 1/2" - 4", class 150 - class 600 Weld stub 1/2" - 1" Threaded bushing G/NPT 1/2" - 1" Threaded nipple G/NPT 1/2" - 1"
Centre-to-centre distance	Min. 150 mm to max. 6,000 mm (larger distances on request)
Material	Stainless steel 1.4571 (316Ti), 1.4404 (316L), 1.4401/1.4404 (316/316L)
Nominal pressure	Max. 64 bar
Temperature range	-196 ... +450 °C
Float	Cylindrical float, model BFT-H or corrugated float, model BFT-S, see data sheet LM 10.02
Magnetic display	Standard version, model BMD-S: < 200 °C High-temperature version, model BMD-F: > 200 °C, see data sheet LM 10.03
Level sensor	Reed sensor, model BLR, see data sheet LM 10.04
Magnetic switches	Magnetic switch, model BGU, see data sheet LM 10.06
Approvals	Ex c, GL, DNV, ABS, GOST-R, IEEEE

Special versions on request

Bypass level indicator, high-pressure version, model BNA-H

Bypass chamber from stainless steel

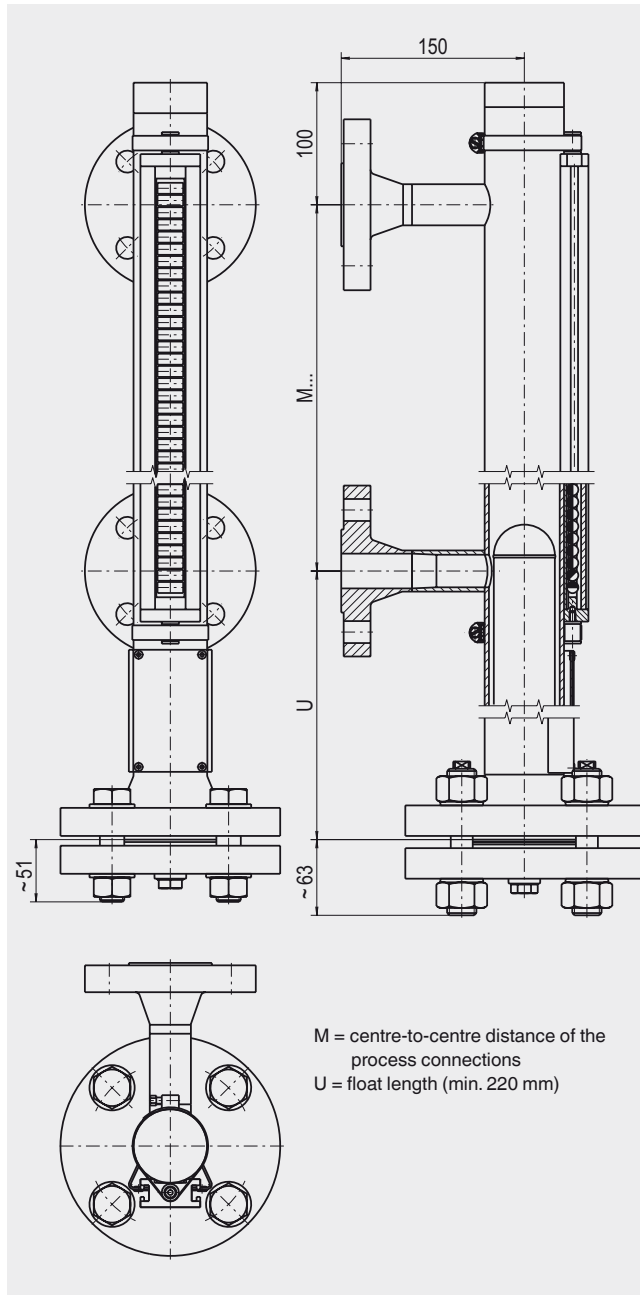

Specifications

Bypass chamber	<p>Stainless steel 1.4571: Ø 60.3 x 3.91 mm, max. 160 bar Ø 76.1 x 5 mm, max. 160 bar Ø 71 x 7.5 mm, max. 250 bar Ø 76.1 x 10 mm, max. 420 bar</p> <p>Stainless steel 1.4404: Ø 60.3 x 3.91 mm, max. 100 bar Ø 60.3 x 5.54 mm, max. 150 bar Ø 73 x 7.01 mm, max. 150 bar</p>
Chamber end top	<p>Flat top or flange connection Options: (see page 14)</p> <ul style="list-style-type: none"> ■ Vent screw ■ Vent valve ■ Vent flange
Chamber end bottom	<p>Flange connection Options: (see page 14)</p> <ul style="list-style-type: none"> ■ Drain plug ■ Drain valve ■ Drain flange
Process connections	<p>2 x lateral (options see page 15) Flange EN 1092-1, DN 10 - DN 100, PN 63 - PN 400 Flange DIN, DN 10 - DN 100, PN 64 - PN 400 Flange ANSI B 16.5, 1/2" - 4", class 600 - class 2,500 Weld stub 1/2" - 1" Threaded bushing G/NPT 1/2" - 1" Threaded nipple G/NPT 1/2" - 1"</p>
Centre-to-centre distance	<p>Min. 150 mm to max. 6,000 mm (larger distances on request)</p>
Material	<p>Stainless steel 1.4571 (Ø 60.3 x 3.91 mm, Ø 76.1 x 5 mm, Ø 71 x 7.5 mm, Ø 76.1 x 10 mm) or stainless steel 1.4404 (Ø 60.3 x 3.91 mm, Ø 60.3 x 5.54 mm, Ø 73 x 7.01 mm)</p>
Nominal pressure	<p>Max. 400 bar</p>
Temperature range	<p>-196 ... +450 °C</p>
Float	<p>Cylindrical float, model BFT-H, ball-segment float, model BFT-K or foam float, model BFT-F, see data sheet LM 10.02</p>
Magnetic display	<p>Standard version, model BMD-S: < 200 °C High-temperature version, model BMD-F: > 200 °C, see data sheet LM 10.03</p>
Level sensor	<p>Reed sensor, model BLR, see data sheet LM 10.04</p>
Magnetic switches	<p>Magnetic switch, model BGU, see data sheet LM 10.06</p>
Approvals	<p>Ex c, GL, DNV, GOST-R</p>

Special versions on request

Bypass level indicator, DUPlus version, standard, model BNA-SD

Bypass chamber from stainless steel

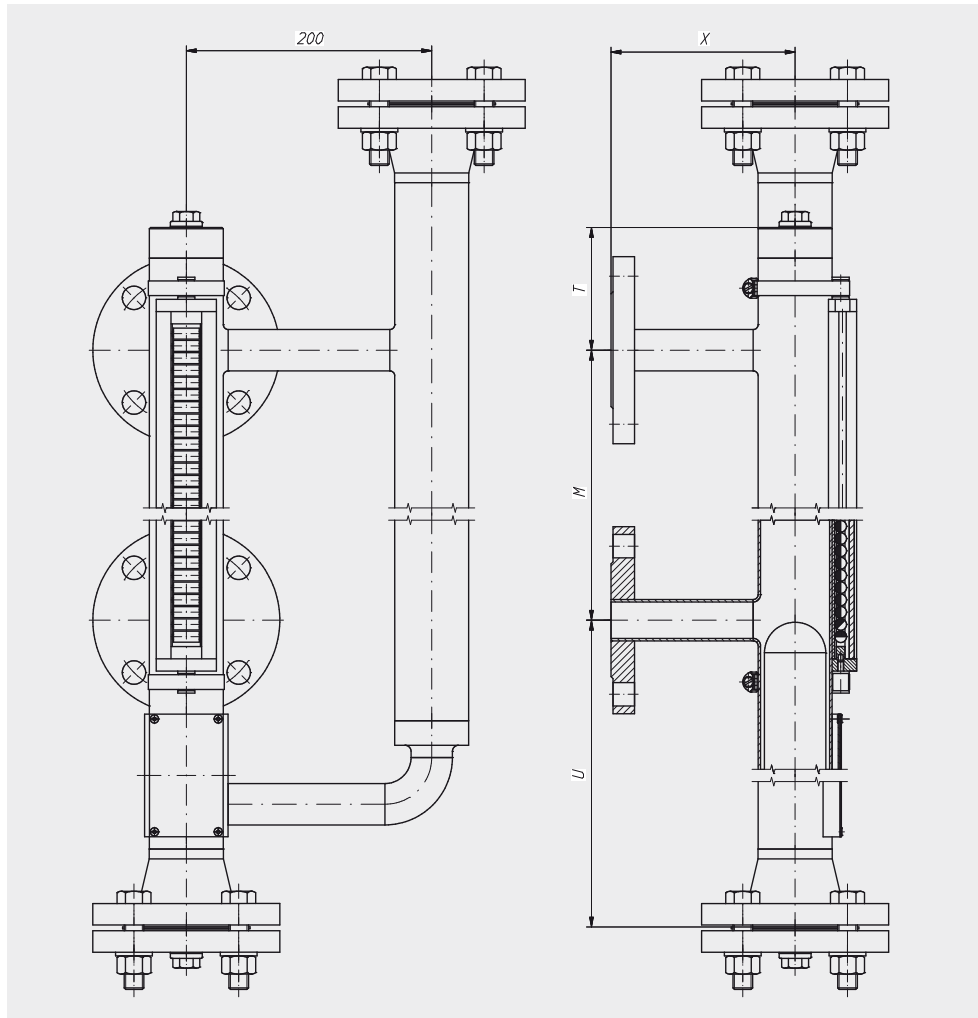

Specifications

Bypass chamber	Ø 60.3 x 2 mm, max. 40 bar Ø 60.3 x 2.77 mm, max. 64 bar
Chamber end top	Flange connection Options: (see page 14) ■ Vent screw ■ Vent valve ■ Vent flange
Chamber end bottom	Flat top or flange connection Options: (see page 14) ■ Drain plug ■ Drain valve ■ Drain flange
Process connections	2 x lateral (options see page 15) Flange DIN, DN 10 - DN 100, PN 6 - PN 64 Flange ANSI B 16.5, 1/2" - 4", class 150 - class 600 Weld stub 1/2" - 1" Threaded bushing G/NPT 1/2" - 1" Threaded nipple G/NPT 1/2" - 1"
External sensor connection	Flange EN 1092-1, DN 50, PN 6 - PN 64 Flange DIN, DN 50, PN 6 - PN 64 Flange ANSI B 16.5, 2" class 150 - class 600 Female thread G/NPT 3/4" - 2"

Centre-to-centre distance	Min. 150 mm to max. 6,000 mm (larger distances on request)
Material	Stainless steel 1.4571, 1.4404 or 1.4401/1.4404
Nominal pressure	Max. 64 bar
Temperature range	-196 ... +450 °C
Float	Cylindrical float, model BFT-H or corrugated float, model BFT-S, see data sheet LM 10.02
Magnetic display	Standard version, model BMD-S: < 200 °C High-temperature version, model BMD-F: > 200 °C, see data sheet LM 10.03
Level sensor	Reed sensor, model BLR, see data sheet LM 10.04
Magnetic switches	Magnetic switch, model BGU, see data sheet LM 10.06
Approvals	Ex c, GOST-R

Special versions on request

Bypass level indicator, DUPlus version, high pressure, model BNA-HD

Bypass chamber from stainless steel

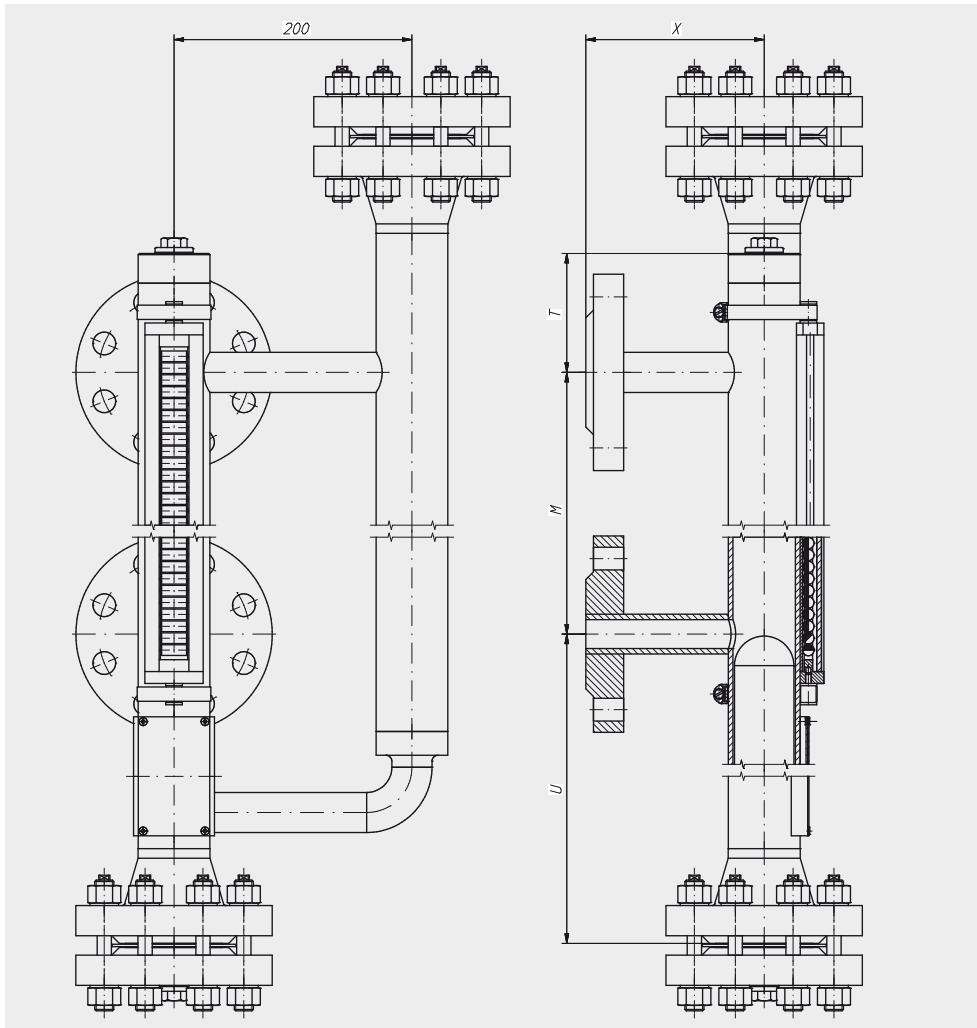

Specifications	
Bypass chamber	Ø 60.3 x 3.91 mm, max. 160 bar
Chamber end top	Flange connection Options: (see page 14) <ul style="list-style-type: none"> ■ Vent screw ■ Vent valve ■ Vent flange
Chamber end bottom	Flat top or flange connection Options: (see page 14) <ul style="list-style-type: none"> ■ Drain plug ■ Drain valve ■ Drain flange
Process connections	2 x lateral (options see page 15) Flange DIN, DN 10 - DN 100, PN 64 - PN 160 Flange ANSI B 16.5, 1/2" - 4", class 600 - class 1,500 Weld stub 1/2" - 1" Threaded bushing G/NPT 1/2" - 1" Threaded nipple G/NPT 1/2" - 1"
External sensor connection	Flange EN 1092-1, DN 50, PN 6 - PN 160 Flange DIN, DN 50, PN 6 - PN 160 Flange ANSI B 16.5, 2" class 150 - class 1,500 Female thread G/NPT 3/4" - 2"

Centre-to-centre distance	Min. 150 mm to max. 6,000 mm (larger distances on request)
Material	Stainless steel 1.4571, 1.4404 or 1.4401/1.4404
Nominal pressure	Max. 160 bar
Temperature range	-196 ... +450 °C
Float	Cylindrical float, model BFT-H, corrugated float, model BFT-S, ball-segment float, model BFT-K or foam float, model BFT-F, see data sheet LM 10.02
Magnetic display	Standard version, model BMD-S: < 200 °C High-temperature version, model BMD-F: > 200 °C, see data sheet LM 10.03
Level sensor	Reed sensor, model BLR, see data sheet LM 10.04
Magnetic switches	Magnetic switch, model BGU, see data sheet LM 10.06
Approvals	Ex c, GOST-R

Special versions on request

Bypass level indicator, special materials, model BNA-X

Bypass chamber from Titanium, Hastelloy or stainless steel 6Mo

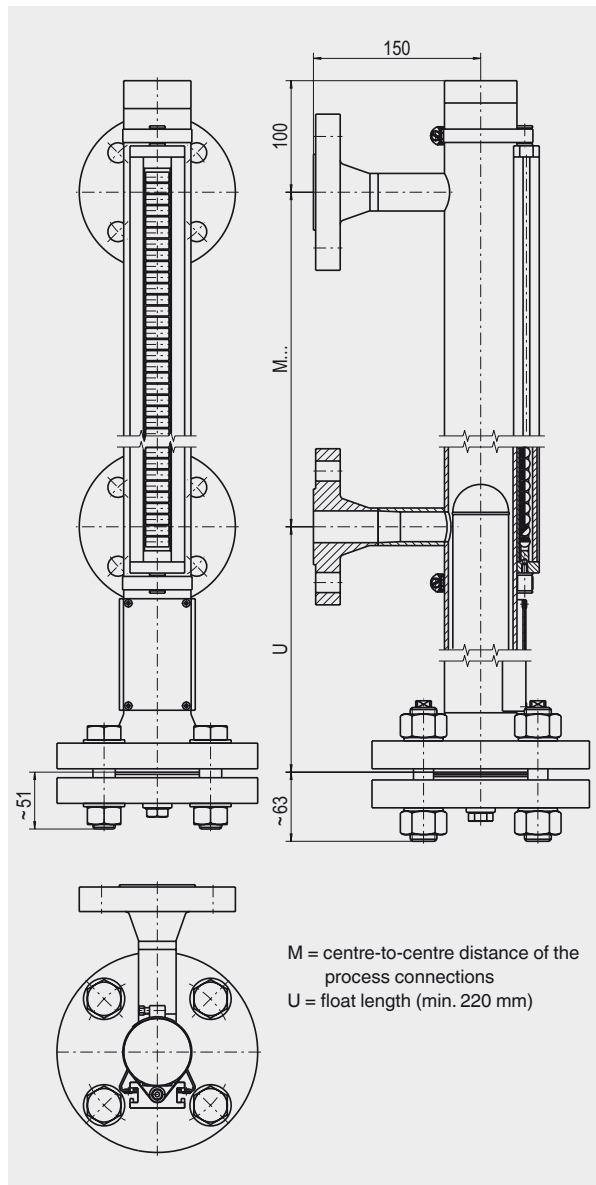

Specifications

Material ¹⁾	Hastelloy C276	Stainless steel 6Mo 1.4547 (UNS S31254)
Bypass chamber	Ø 60.3 x 2.77 mm, max. 64 bar Ø 60.3 x 3.91 mm, max. 160 bar	Ø 60.3 x 2.77 mm, max. 64 bar Ø 60.3 x 3.91 mm, max. 160 bar Ø 60.3 x 5.54 mm, max. 250 bar
Chamber end top		
Chamber end bottom		
Process connections (2 x lateral, options see page 15)	Flange EN 1092-1, DN 10 - DN 100, PN 6 - PN 400 Flange DIN, DN 10 - DN 100, PN 6 - PN 400 Flange ANSI B 16.5, 1/2" - 4", class 150 - class 2,500	Flange EN 1092-1, DN 10 - DN 100, PN 63 - PN 400 Flange DIN, DN 10 - DN 100, PN 64 - PN 400 Flange ANSI B 16.5, 1/2" - 4", class 600 - class 2,500
Centre-to-centre distance		
Nominal pressure	Max. 160 bar	Max. 250 bar
Temperature range		
Float		
Magnetic display		
Level sensor		
Magnetic switches		
Approvals	Ex c, GL, DNV, GOST-R	Ex c, GOST-R

1) Other materials on request

Special versions on request

Option bypass chamber end

Bypass chamber end top (examples)

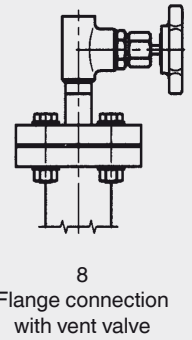
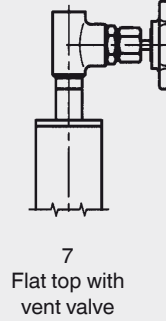
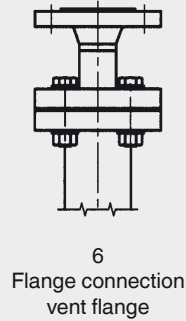
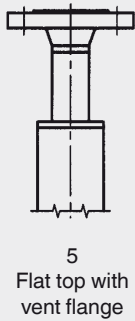
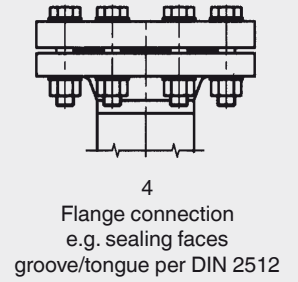
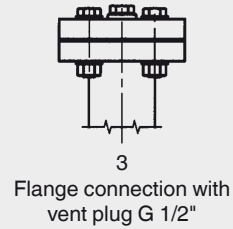
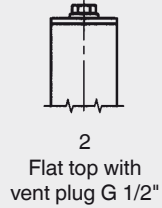
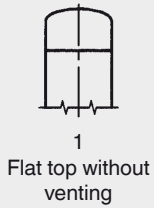

Other ends on request

Bypass chamber end bottom (examples)

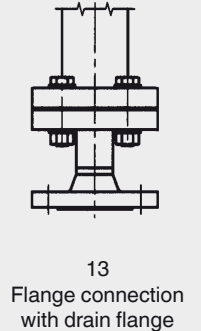
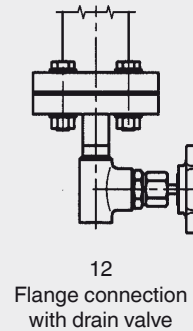
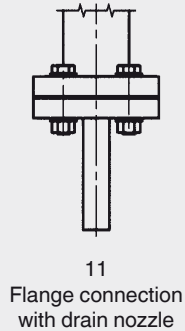
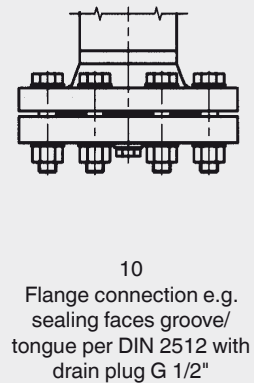
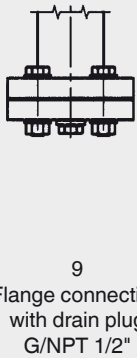

Other ends on request

Option process connection

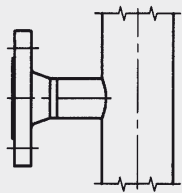

14
Welding neck flange
up to DN 25

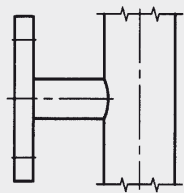

15
Blind flange
above DN 32

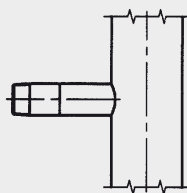

16
Threaded coupling
GN ... (male thread)

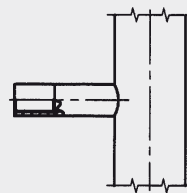

17
Threaded coupling
GM ... (female thread)

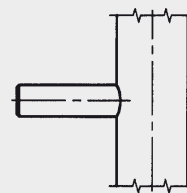

18
Weld stub S ...

Examples

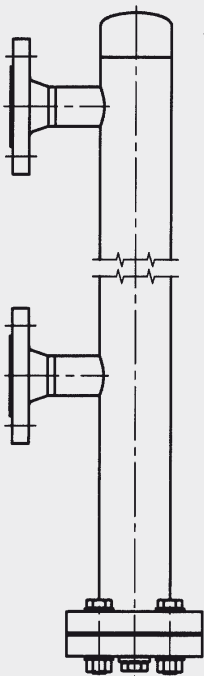

19
Standard version
Process connections
2 x lateral

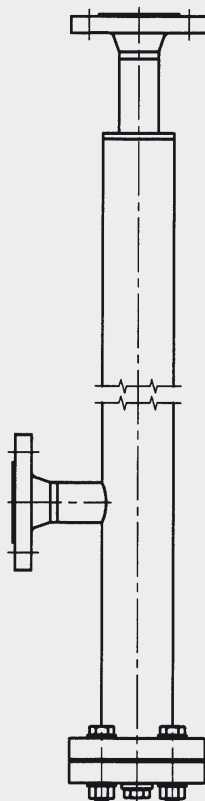

20
1 process connection lateral
1 process connection vertical
(top)

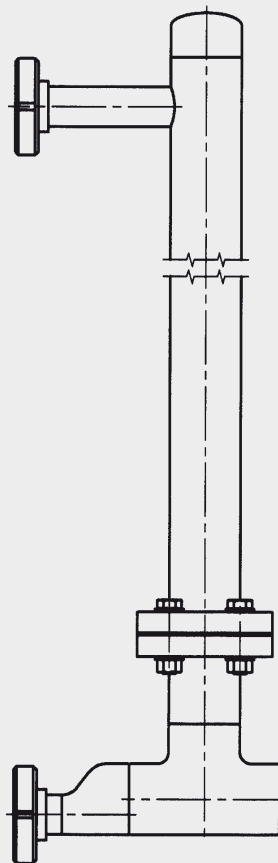

21
2 process connections
to DIN 11851
Lower process connection via
eccentric reducer

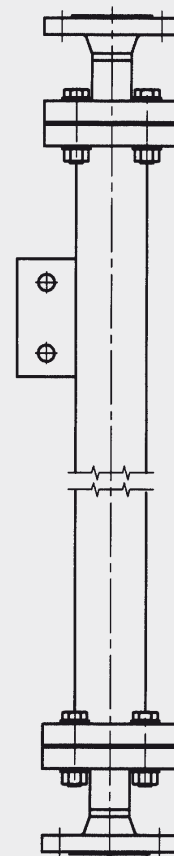

22
2 process connections
vertical (top/bottom)
Option: Support bracket

Other connections on request

CE conformity

Pressure equipment directive

97/23/EC, pressure accessory

ATEX directive (option)

94/9/EC, ignition protection type Ex c, zone 0/1, gas

Approvals

- **GL**, ships, shipbuilding, offshore, Germany
- **DNV**, ships, shipbuilding, offshore, Norway
- **ABS**, ships, shipbuilding, offshore, USA
- **GOST**, national standard for Russia, Kazakhstan and Belarus
- **IEEE 344**, standard for seismic qualification of equipment for nuclear power generating stations

Approvals and certificates, see website

Detailed information on floats, magnetic displays, sensors (reed chains) and magnetic switches can be found in the following data sheets:

- Float, model BFT
- Magnetic display; model BMD
- Reed sensor; model BLR
- Magnetic switch; model BGU

© 2014 KSR KUEBLER Niveau-Messtechnik AG, all rights reserved.
The specifications given in this document represent the state of engineering at the time of publishing.
We reserve the right to make modifications to the specifications and materials.



KSR KUEBLER Niveau-Messtechnik AG
Heinrich-Kuebler-Platz 1
69439 Zwingenberg/Germany
Tel. +49 6263 87-0
Fax +49 6263 8799
info@ksr-kuebler.com
www.ksr-kuebler.com